

Switch Mode Power Supply (120/240/480/960 W Models)

S8VK-T

Renewal of 400 V, 3-phase standard type. 480 W/960 W feature PFC for lower input current and higher efficiency (93% typ.) than conventional products

- Wide input range for worldwide applications:
380 to 480 VAC (3-phase, 320 to 576 VAC)
- Wide operation temperature range: -40 to 70°C
- Power Boost function at 120%
- Conforms to various safety and noise standards *1
- Three years Warranty *2

*1. For details on conformance standards, refer to *Standards under Ratings, Characteristics, and Functions* on page 3 to 4.

*2. For details, refer to *Recommended Replacement Periods and Periodic Replacement for Preventive Maintenance* on page 18.



For the most recent information on models that have been certified for safety standards, refer to your local OMRON website.

 Refer to *Safety Precautions for All Power Supplies* and *Safety Precautions* on page 13.

Related Products

**DC Electronic Circuit Protector
S8V-CP**



Note: Refer to the S8V-CP Datasheet (Cat. No. T226-E1) for details.

S8VK-T

Model Number Structure

Model Number Legend

S8VK-T□□□□□□
 1 2

1. Power Ratings

120: 120 W
240: 240 W
480: 480 W
960: 960 W

2. Output voltage

24: 24 V

Ordering Information

Note: For details on normal stock models, contact your nearest OMRON representative.

Power ratings	Rated Input voltage	Rated Output Voltage	Rated Output current	Maximum Boost Current	Model number
120 W	2-phase and 3-phase 380 to 480 VAC 450 to 600 VDC	24 V	5 A	6 A	S8VK-T12024
240 W		24 V	10 A	12 A	S8VK-T24024
480 W		24 V	20 A	24 A	S8VK-T48024
960 W	3-phase, 2-phase 380 to 480 VAC	24 V	40 A	48 A	S8VK-T96024

Specifications

Ratings, Characteristics, and Functions

Item	Power rating		120 W	240 W
	Output voltage		24 V	24 V
Efficiency *1	3-phase, 400 VAC input		89% typ.	89% typ.
Input	Voltage range *2		3-phase, 380 to 480 VAC (allowable range: 320 to 576 VAC) 2-phase, 380 to 480 VAC (allowable range: 340 to 576 VAC) 450 to 600 VDC (allowable range: 450 to 810 VDC)	
	Frequency *2		50/60 Hz (47 to 63 Hz)	
	Input Current *1	3-phase, 400 VAC input	0.40 A typ.	0.74 A typ.
	Power factor *6	3-phase, 400 VAC input	-	-
	Leakage current *3	3-phase, 400 VAC input	3.5 mA max./0.70 mA typ.	3.5 mA max./0.80 mA typ.
Inrush current (for a cold start at 25°C) *4	3-phase, 400 VAC input	28 A typ.	29 A typ.	
Output	Rated output current		5 A	10 A
	Boost current		6 A	12 A
	Voltage adjustment range *5		24 to 29.5 VDC (with V.ADJ) (guaranteed)	
	Ripple & Noise voltage *6	3-phase, 400 VAC input	40 mV p-p max. at 20 MHz of bandwidth	50 mV p-p max. at 20 MHz of bandwidth
	Input variation influence *7		0.5% max.	
	Load variation influence *8		1.5% max.	
	Temperature variation influence	3-phase, 400 VAC input	0.05%/°C max.	
	Start up time *9	3-phase, 400 VAC input	600 ms typ.	600 ms typ.
Hold time *9	3-phase, 400 VAC input	35 ms typ.	25 ms typ.	
Additional functions	Overload protection		Yes, automatic reset, intermittent operation type, Refer to <i>Overload Protection</i> on page 9 for details.	
	Overvoltage protection		Yes, 130% or higher of rated output voltage, power shut off (shut off the input voltage and turn on the input again), Refer to <i>Overvoltage Protection</i> on page 9 for details.	
	Series operation		Yes (For up to two Power Supplies, external diodes are required.)	
	Parallel operation		Yes (For up to two Power Supplies), Refer to <i>Parallel Operation</i> on page 16 for details.	
	Output indicator		Yes (LED: Green), lighting from 80% to 90% or more of rated voltage	
Insulation	Withstand voltage		3.0 kVAC for 1 min. (between all input terminals and output terminals) cutoff current 20 mA 2.5 kVAC for 1 min. (between all input terminals and PE terminal) cutoff current 20 mA 1.0 kVAC for 1 min. (between all output terminals and PE terminal) cutoff current 30 mA	
	Insulation resistance		100 MΩ min. (between all output terminals and all input terminals / PE terminal) at 500 VDC	
Environment	Ambient operating temperature *10		-40 to 70°C (However, only startup is guaranteed for between -40°C to -25°C. (3-phase only)) (Derating is required according to the temperature.) (with no condensation or icing)	
	Storage temperature		-40 to 85°C (with no condensation or icing)	
	Ambient operating humidity		0% to 95% (Storage humidity: 0% to 95%)	
	Vibration resistance *11		10 to 55 Hz, 0.375-mm half amplitude for 2 h each in X, Y, and Z directions	
	Shock resistance *11		150 m/s ² , 3 times each in ±X, ±Y, and ±Z directions	
Reliability	MTBF *12		135,000 hrs min.	
	Life expectancy *13		10 years min.	
Construction	Weight		650 g max.	850 g max.
	Cooling fan		No	
	Degree of protection		IP20 by EN / IEC 60529	
Standards	Harmonic current emissions		Conforms to EN 61000-3-2 (3-phase, 2-phase)	
	EMI	Conducted Emission	Conforms to EN 61204-3 Class B, EN 55011 Class B (3-phase, 2-phase)	
		Radiated Emission		
	EMS		EN 61204-3 high severity levels	
	Safety standards		UL 508 (Listing) UL 61010-2-201 (Listing) OVCIII/OVCII Pol2 *16 CSA C22.2 No.61010-2-201 (cUL) OVCIII/OVCII Pol2 *16 EN/IEC 61010-2-201 OVCIII/OVCII Pol2 *16 EN/IEC 62477-1 OVCIII Pol2 *15 RCM (EN61000-6-4) Lloyd's standards *17 Conforms to SELV(EN/IEC 61558-2-16) Conforms to PELV (EN/IEC 60204-1) Conforms to EN/IEC 61558-2-16 *15 BIS (IS 13252 (Part1))	
SEMI		Conforms to F47-0706 (3-phase, 380 to 480 VAC input)		

Note: Refer to page 5 for notes 1 to 17.

S8VK-T

Item	Power rating		480 W	960 W
	Output voltage		24 V	24 V
Efficiency *1	3-phase, 400 VAC input		93% typ.	93% typ.
Input	Voltage range *2		3-phase, 380 to 480 VAC (allowable range: 320 to 576 VAC) 2-phase, 380 to 480 VAC (allowable range: 340 to 576 VAC) 450 to 600 VDC (allowable range: 450 to 810 VDC)	3-phase, 380 to 480 VAC (allowable range: 320 to 576 VAC) 2-phase, 380 to 480 VAC (allowable range: 340 to 576 VAC)
	Frequency *2		50/60 Hz (47 to 63 Hz)	
	Input Current *1	3-phase, 400 VAC input	0.80 A typ.	1.6 A typ.
	Power factor *6	3-phase, 400 VAC input	0.9 min.	
	Leakage current *3	3-phase, 400 VAC input	3.5 mA max./1.0 mA typ.	3.5 mA max./1.2 mA typ.
	Inrush current (for a cold start at 25°C) *4	3-phase, 400 VAC input	4 A typ.	6 A typ.
Output	Rated output current		20 A	40 A
	Boost current		24 A	48 A
	Voltage adjustment range *5		24 to 29.5 VDC (with V.ADJ) (guaranteed)	
	Ripple & Noise voltage *6	3-phase, 400 VAC input	30 mV p-p max. at 20 MHz of bandwidth	60 mV p-p max. at 20 MHz of bandwidth
	Input variation influence *7		0.5% max.	
	Load variation influence *8		1.5% max.	
	Temperature variation influence	3-phase, 400 VAC input	0.05%/°C max.	
	Start up time *9	3-phase, 400 VAC input	500 ms typ.	500 ms typ.
	Hold time *9	3-phase, 400 VAC input	40 ms typ.	35 ms typ.
Additional functions	Overload protection		Yes, automatic reset, intermittent operation type, Refer to <i>Overload Protection</i> on page 9 for details.	
	Overvoltage protection		Yes, 130% or higher of rated output voltage, power shut off (shut off the input voltage and turn on the input again), Refer to <i>Overvoltage Protection</i> on page 9 for details.	
	Series operation		Yes (For up to two Power Supplies, external diodes are required.)	
	Parallel operation		Yes (For up to two Power Supplies), Refer to <i>Parallel Operation</i> on page 16 for details. For 960 W, set the operation switch to the "PARALLEL" side (limit the rated output current to 80%).	
	Output indicator		Yes (LED: Green), lighting from 80% to 90% or more of rated voltage	
Insulation	Withstand voltage		3.0 kVAC for 1 min. (between all input terminals and output terminals) cutoff current 20 mA 2.5 kVAC for 1 min. (between all input terminals and PE terminal) cutoff current 20 mA 1.0 kVAC for 1 min. (between all output terminals and PE terminal) cutoff current 30 mA	
	Insulation resistance		100 MΩ min. (between all output terminals and all input terminals / PE terminal) at 500 VDC	
Environment	Ambient operating temperature *10		-40 to 70°C (However, only startup is guaranteed for between -40°C to -25°C. (3-phase only)) (Derating is required according to the temperature.) (with no condensation or icing)	
	Storage temperature		-40 to 85°C (with no condensation or icing)	
	Ambient operating humidity		0% to 95% (Storage humidity: 0% to 95%)	
	Vibration resistance *11		10 to 55 Hz, 0.375-mm half amplitude for 2 h each in X, Y, and Z directions	
	Shock resistance *11		150 m/s ² , 3 times each in ±X, ±Y, and ±Z directions	
Reliability	MTBF *12		135,000 hrs min.	
	Life expectancy *13		10 years min.	
Construction	Weight		1,400 g max.	2,000 g max.
	Cooling fan		No	
	Degree of protection		IP20 by EN / IEC 60529	
Standards	Harmonic current emissions		Conforms to EN 61000-3-2 (3-phase, 2-phase)	Conforms to EN61000-3-2 (3-phase, 2-phase) *14
	EMI	Conducted Emission	Conforms to EN 61204-3 Class B, EN 55011 Class B (3-phase, 2-phase)	Conforms to EN 61204-3 Class B, EN 55011 Class B (3-phase: 100% or less of rated output current) (2-phase: 45% or less of rated output current) Conforms to EN 61204-3 Class A, EN 55011 Class A (2-phase: 45 to 100% of rated output current)
		Radiated Emission		
	EMS		EN 61204-3 high severity levels	
	Safety standards		UL 508 (Listing) UL 61010-2-201 (Listing) OVCIII/OVCII Pol2 *16 CSA C22.2 No.61010-2-201 (cUL) OVCIII/OVCII Pol2 *16 EN/IEC 61010-2-201 OVCIII/OVCII Pol2 *16 EN/IEC 62477-1 OVCIII Pol2 *15 RCM (EN61000-6-4) Lloyd's standards *17 Conforms to SELV (EN/IEC 61558-2-16) Conforms to PELV (EN/IEC 60204-1) Conforms to EN/IEC 61558-2-16 *15 BIS (IS 13252 (Part1))	
SEMI		Conforms to F47-0706 (3-phase, 380 to 480 VAC input)		

Note: Refer to page 5 for notes 1 to 17.

- *1. The value is when both rated output voltage and rated output current are satisfied.
- *2. Do not use an inverter output for the product. Inverters with an output frequency of 50/60 Hz are available, but the rise in the internal temperature of the product may result in ignition or burning. If the input is connected to a UPS, do not connect a UPS with a square-wave output. Doing so will cause the internal temperature of the product to increase, possibly causing smoking or burning.
- *3. The value is determined according to the Electrical Appliances and Material Safety Act.
- *4. Values for a cold start at 25°C. Refer to *Inrush Current, Startup Time, Output Hold Time* on page 9 for details.
- *5. If the output voltage adjuster (V. ADJ) is turned, the voltage will increase by more than the voltage adjustment range. When adjusting the output voltage, confirm the actual output voltage from the product and be sure that the load is not damaged.
- *6. The value is when both rated output voltage and rated output current are satisfied. A characteristic when the ambient operating temperature is 25°C.
- *7. This is the maximum variation in the output voltage when the input voltage is gradually changed within the allowable input voltage range at the rated output voltage and rated output current.
- *8. When the input voltage is 380 to 480 VAC, this is the maximum variation in the output voltage when the output current is gradually changed within the range of 0 A to the rated output current.
- *9. The value is when rated output voltage, rated output current, and room temperature (25°C) are satisfied. Refer to *Inrush Current, Startup Time, Output Hold Time* on page 9 for details.
- *10. At -40 to -25°C, time will be required before the rated output voltage is output after the input voltage is input. Also, the ripple noise value may exceed the value shown in the above table. (3-phase 380 to 480 VAC input only)
- *11. If there is a possibility that the Unit will be subject to vibration or shock, use a steel DIN Rail.
- *12. MTBF is calculated according to JEITA RCR-9102.
- *13. Refer to *Recommended Replacement Periods and Periodic Replacement for Preventive Maintenance* on page 18 for details.
- *14. When using 2-phase input, conforms to EN 61000-3-2 under the following condition
960W: At the rated output voltage, and 80% or less than the rated output current
- *15. In order to comply with the safety standards, the input must be connected to the product via the recommended circuit breaker or fuse. Refer to *Recommended Circuit-breakers and Fuses* on page 14 for details.
- *16. AC input overvoltage categories UL 61010-2-201, EN/IEC 61010-2-201, and CSA C22.2 No. 61010-2-201 are shown in the table to the right.
For the input distribution system, refer to *Network Types* on page 14.
- *17. For certification conditions, refer to *Standard Compliance* blow.

3-phase/2-phase	TN-S	TN-C	TT	IT
Y connection	OVCIII	OVCIII	OVCIII	OVCII
Delta connection	---	OVCII	OVCII	OVCII

Standard Compliance

- To comply with PELV output requirements for EN/IEC 60204-1, ground the negative side of the output (-V) to a protective earth (PE).
- EN/IEC 61558-2-16
The S8VK-T was designed based on EN/IEC 61558-2-16.
Currently, IEC 61558-2-17 has been replaced by IEC 61558-2-16.
When certification was received for EN/IEC 60204-1 (Machinery Safety), it was necessary to go through a control transformer to the control circuits. However, a control transformer is not always necessary for products that have been certified for the safety standard for OVCIII or for products that use a transformer that conforms to EN/IEC 61558-2-16.
- Safety Standards for a DC Input
For DC input, EN/IEC 62477-1, EN/IEC 61558-2-16, and LR are subject to safety standards.
In addition, for DC input, connect the positive voltage to the +L1 terminal and negative voltage to the -L2 terminal.
For details on selecting a UL-certified fuse, refer to *Recommended Circuit-breakers and Fuses* on page 14.
- Conformance to Marine Standards
Fix an End Plate (PFP-M) to both sides of the unit to hold it in place. (S8VK-T Series)
Use S82Y-VK90F front-mounting bracket for 480 W.
Side-mounting brackets are not compliant.
A noise filter manufactured by SCHAFFNER Corporation (FH3288-10-44-C34-R65) or equivalent should be connected to the input terminals. (S8VK-T96024 only)

S8VK-T

Connections

Block Diagrams

S8VK-T12024 (120 W)

S8VK-T24024 (240 W)

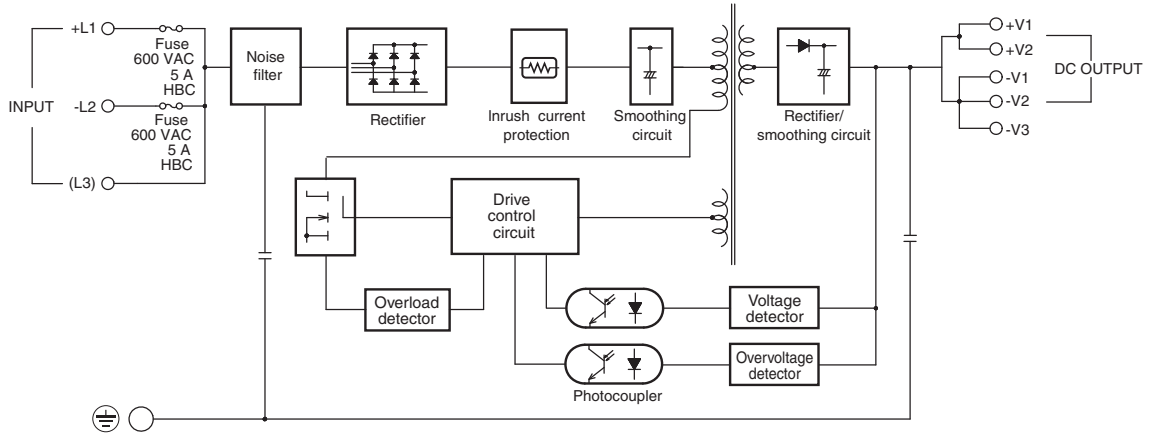

S8VK-T48024 (480 W)

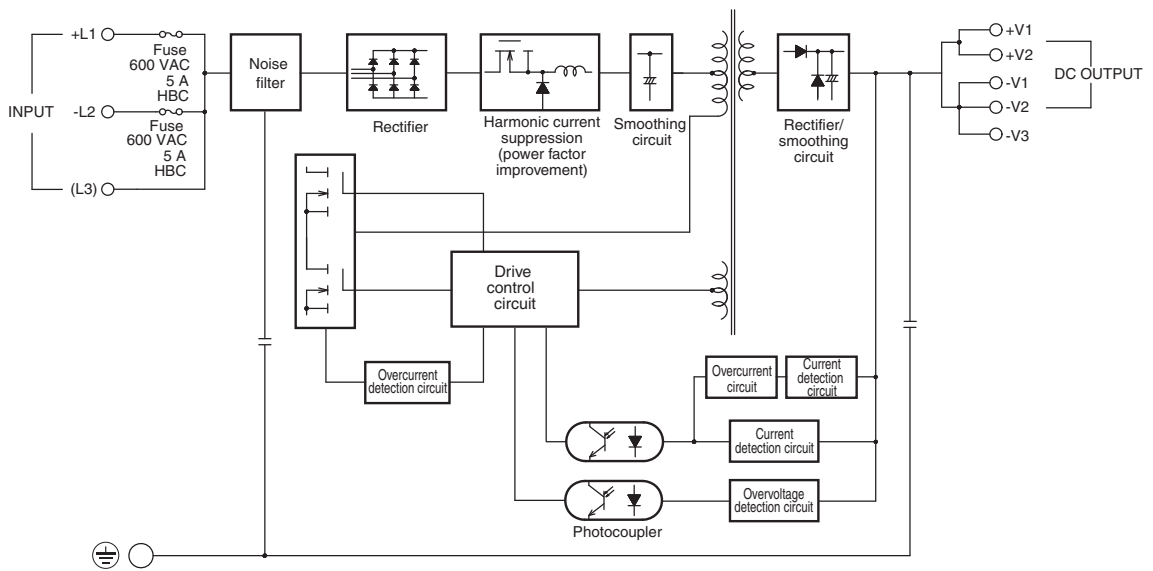

S8VK-T96024 (960 W)

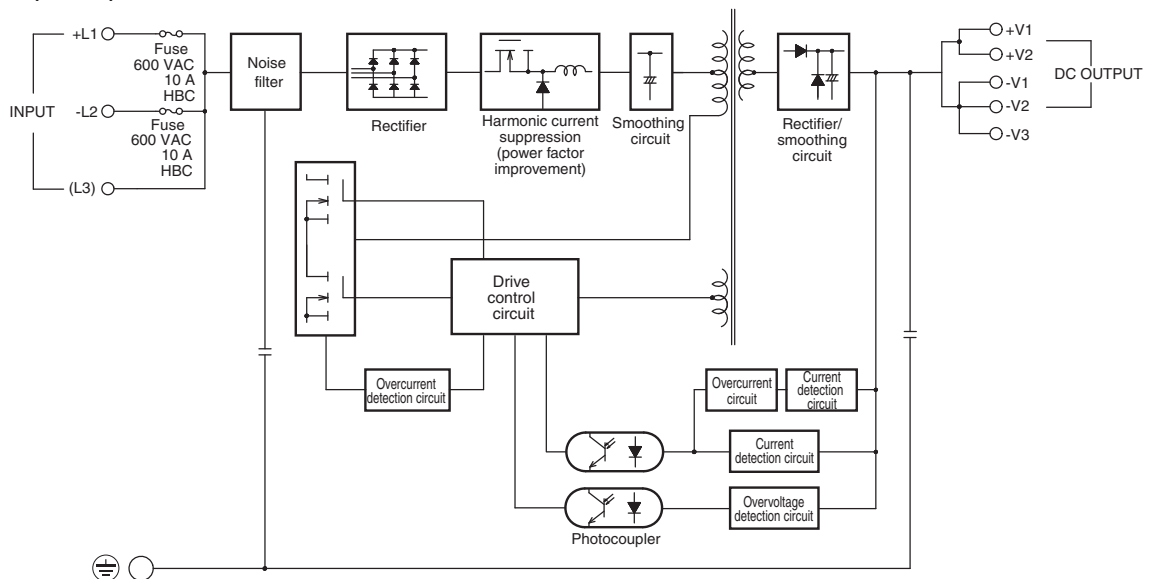

Construction and Nomenclature

Nomenclature

120 W Model

S8VK-T12024

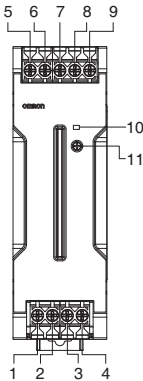

240 W Model

S8VK-T24024

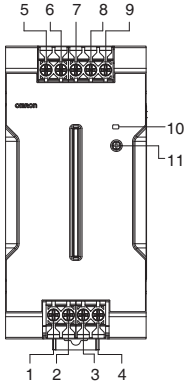

480 W Model

S8VK-T48024

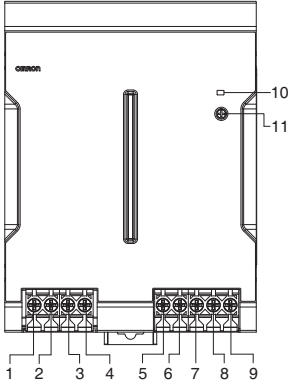

960 W Model

S8VK-T96024

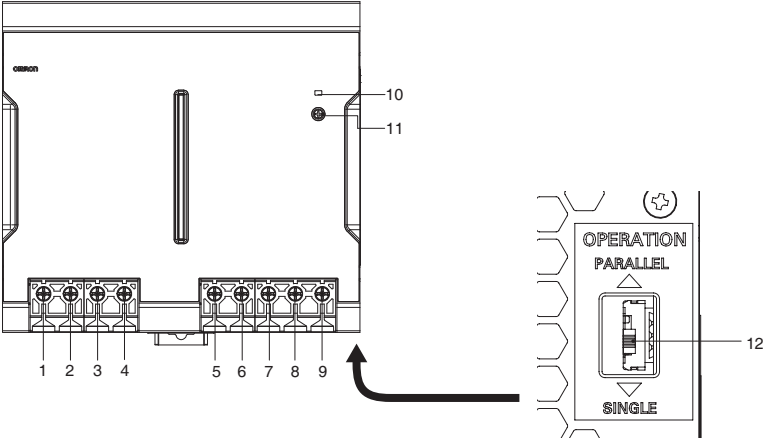

No.	Terminal name	Name	Function
1	+L1	Input terminals	Connect the input lines to these terminals. *1
2	-L2		
3	(L3)		
4	PE	Ground / PE (protective earthing) terminal (⊕)	Connect the ground line to this terminal. *2
5	+V1	DC Output terminals	Connect the load lines to these terminals.
6	+V2		
7	-V1		
8	-V2		
9	-V3		
10	---	Output indicator (DC ON: Green)	Lights up when the output voltage is more than 90% of the rated output voltage.
11	---	Output voltage adjuster (V.ADJ)	Use to adjust the voltage.
12	---	Operation switch (OPERATION)	Set the switch to "PARALLEL" if the units are in parallel operation. SINGLE : The output current can use 100% of the rated output current. PARALLEL : Overcurrent protection limits the output current to 80% of the rated output current.

*1. Connect it to the +L1 and -L2 terminals at 2-phase input. Connect the positive voltage to the +L1 terminal and negative voltage to the -L2 terminal at DC input.
(Refer to the wiring diagram under *Recommended Circuit-breakers and Fuses* on page 14.)

*2. This is the protective earth terminal specified in the safety standards. Always ground this terminal.

S8VK-T

Engineering Data

Derating Curve

120 W (S8VK-T12024)

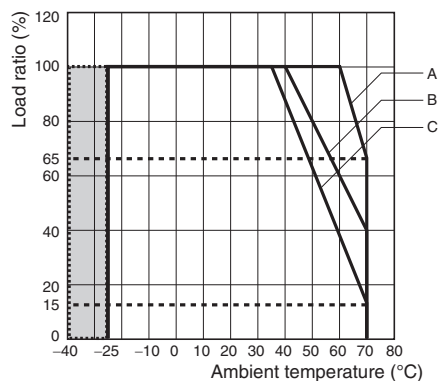

Note: This is the guaranteed value for startup. (3-phase only)

- A. Standard mounting
- B. Face-up mounting at 480 VAC or lower or 678 VDC or lower
- C. Face-up mounting at 576 VAC or lower or 810 VDC or lower

240 W (S8VK-T24024)

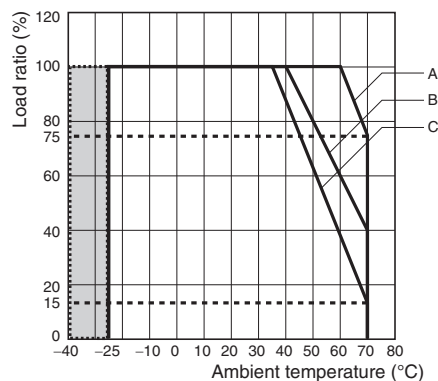

Note: This is the guaranteed value for startup. (3-phase only)

- A. Standard mounting
- B. Face-up mounting at 480 VAC or lower or 678 VDC or lower
- C. Face-up mounting at 576 VAC or lower or 810 VDC or lower

480 W (S8VK-T48024)

960 W (S8VK-T96024)

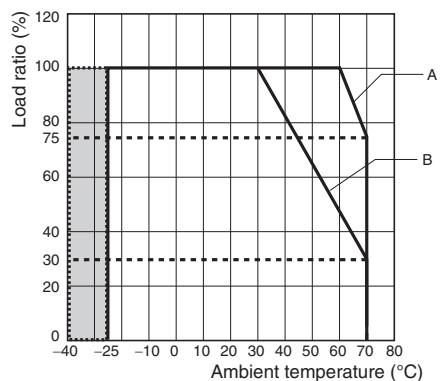

Note: This is the guaranteed value for startup. (3-phase only)

- A. Standard mounting
- B. Face-up mounting

960 W (S8VK-T96024): In parallel operation

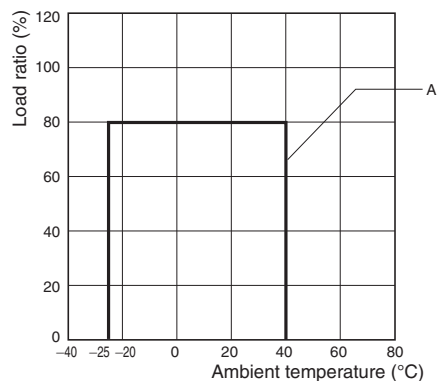

Note: 1. Set the parallel operation switch to the "PARALLEL" side (limit the rated output current to 80%).
2. For usage conditions, refer to *Parallel Operation* on page 16.

- A. Standard mounting (3-phase input voltage only)

Mounting

(A) Standard (Vertical) mounting

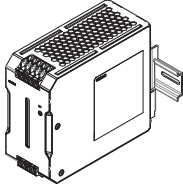

(B) Face-up mounting

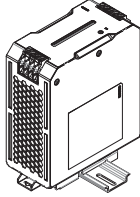

Overload Protection

The load and the product are automatically protected from overcurrent damage by this function. Overload protection is activated if the output current rises above 121% of the rated current. When the output current returns within the rated range, overload protection is automatically cleared.

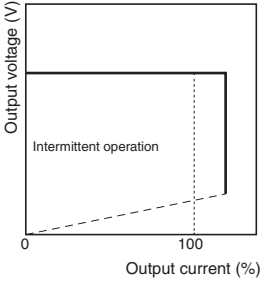

The values shown in the above diagrams are for reference only.

- Note:**
1. Internal parts may occasionally deteriorate or be damaged if a short-circuited or overcurrent state continues during operation.
 2. Internal parts may possibly deteriorate or be damaged if the Power Supply is used for applications with frequent inrush current or overloading at the load end. Do not use the Power Supply for such applications.

Overvoltage Protection

Overvoltage will be detected to prevent the load from being subjected to excessive voltage when the feedback circuit in the Power Supply fails, etc. If an excessive voltage that is approximately 130% of the rated voltage or more is output, the output voltage is shut OFF. Reset the input power by turning it OFF for at least five minutes and then turning it back ON again.

Note: Do not turn ON the power again until the cause of the overvoltage has been removed.

Inrush Current, Startup Time, Output Hold Time

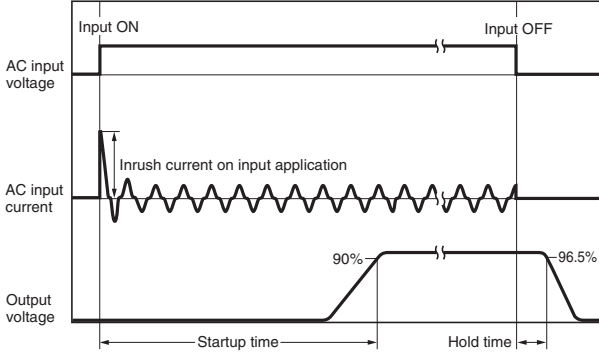

Note: Twice the input current or above will flow during the parallel operation or redundant system. Therefore, check the fusing characteristics of fuses and operating characteristics of circuit breakers making sure that the external fuses will not burn out and the circuit breakers will not be activated by the inrush current.

Reference Value

	Value
Reliability (MTBF)	120 W: 330,000h 240 W: 330,000h 480 W: 180,000h 960 W: 150,000h
Definition	MTBF stands for Mean Time Between Failures, which is calculated according to the probability of accidental device failures, and indicates reliability of devices. Therefore, it does not necessarily represent a life of the product.
Life expectancy	10 years. Min.
Definition	The life expectancy indicates average operating hours under the ambient temperature of 40°C and a load rate of 50%. Normally this is determined by the life expectancy of the built-in aluminum electrolytic capacitor.

S8VK-T

Dimensions

(Unit: mm)

S8VK-T12024 (120 W)

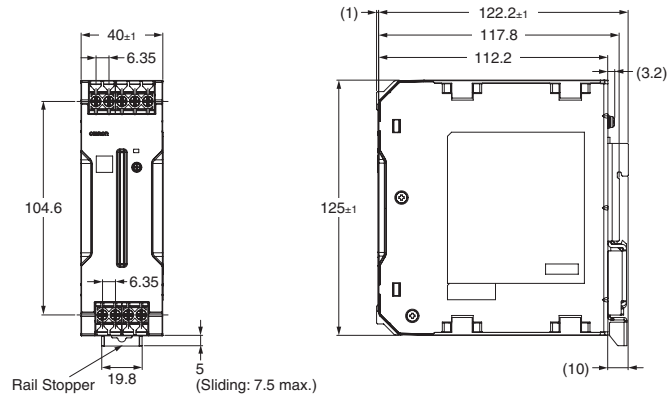

S8VK-T24024 (240 W)

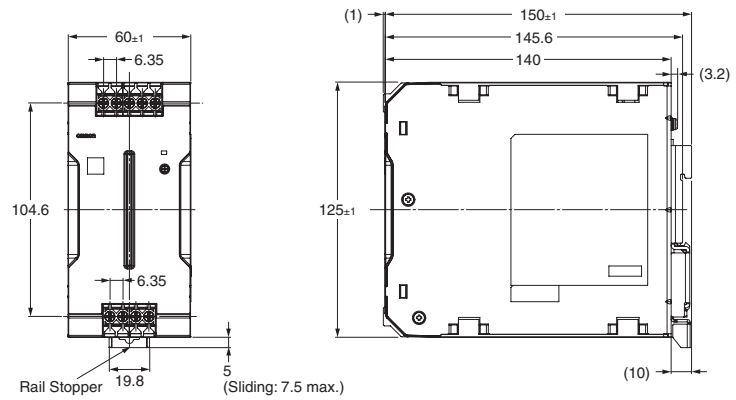

S8VK-T48024 (480 W)

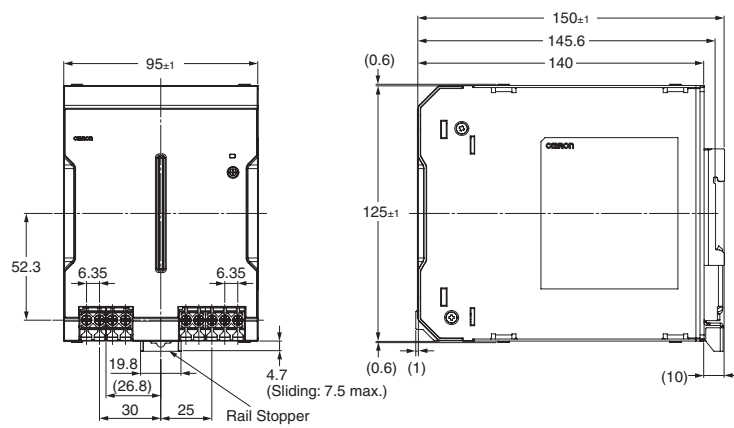

S8VK-T96024 (960 W)

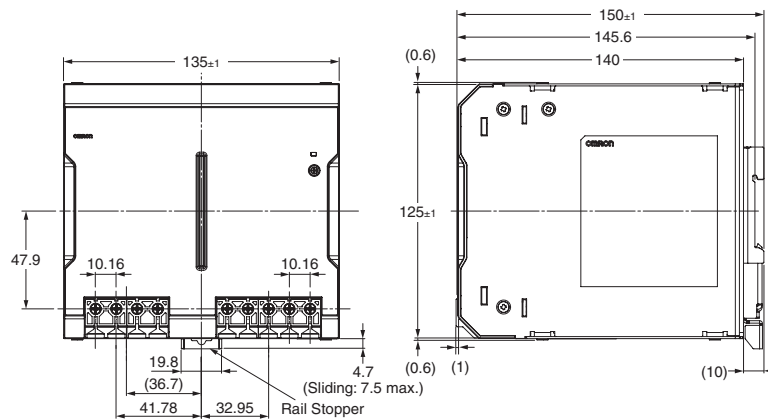

DIN Rail (Order Separately)

Note: All units are in millimeters unless otherwise indicated.

End Plate

FFP-M

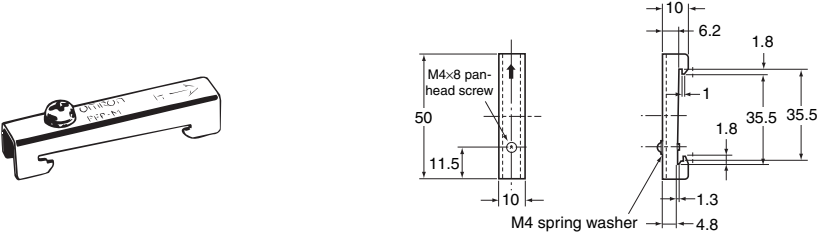



Mounting Brackets

Name	Model	Qty used
Front-mounting bracket (for 120, 240 and 480 W models)	S82Y-VK10F	1
Front-mounting bracket (for 480 and 960 W model)	S82Y-VK90F	1
Side-mounting bracket (for 120 W model)	S82Y-VK10S	1
Side-mounting bracket (for 240 W model)	S82Y-VK20S	1

Note: Be sure to use the accessory screws.
 Mounting screw tightening torque (recommended): 4.43 to 5.31 lb-in (0.5 to 0.6 N·m)

Type	Model	Dimensions	Appearance
Front-mounting bracket (for 120, 240 and 480 W models) *1	S82Y-VK10F		
Front-mounting bracket (for 480 and 960 W models) *1*2	S82Y-VK90F		

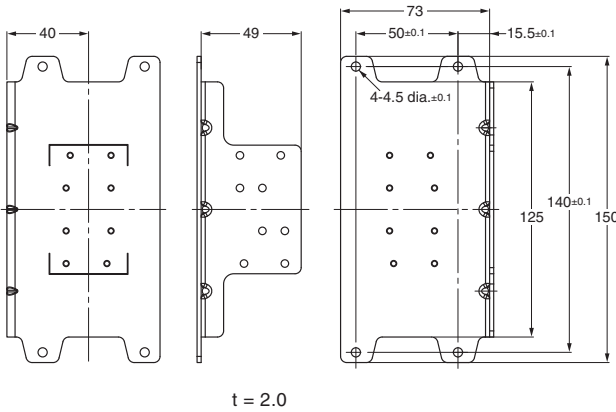
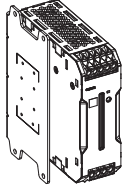
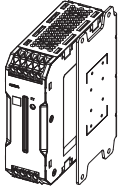
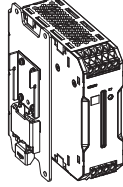
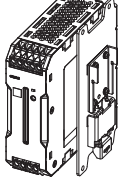
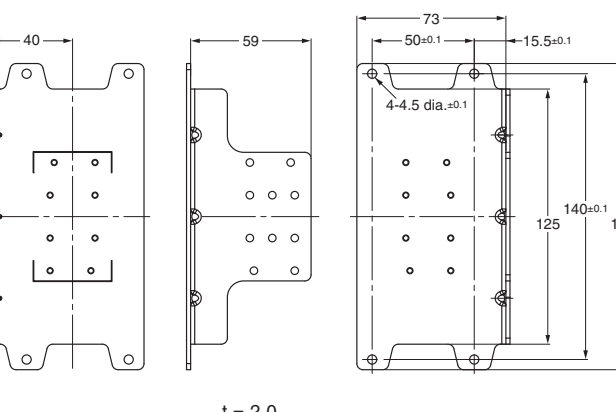
S8VK-T

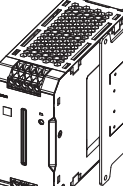
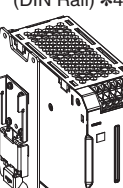
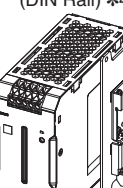
Type	Model	Dimensions	Appearance
Side-mounting bracket (For 120 W model) *3	S82Y-VK10S	 <p style="text-align: center;">t = 2.0</p>	<div style="display: flex; justify-content: space-around;"> <div style="text-align: center;"> <p>Left-side mounting</p>  </div> <div style="text-align: center;"> <p>Right-side mounting</p>  </div> </div> <div style="display: flex; justify-content: space-around; margin-top: 10px;"> <div style="text-align: center;"> <p>Left-side mounting (DIN Rail) *4</p>  </div> <div style="text-align: center;"> <p>Right-side mounting (DIN Rail) *4</p>  </div> </div>
Side-mounting bracket (For 240 W model) *3	S82Y-VK20S	 <p style="text-align: center;">t = 2.0</p>	<div style="display: flex; justify-content: space-around;"> <div style="text-align: center;"> <p>Left-side mounting</p>  </div> <div style="text-align: center;"> <p>Right-side mounting</p>  </div> </div> <div style="display: flex; justify-content: space-around; margin-top: 10px;"> <div style="text-align: center;"> <p>Left-side mounting (DIN Rail) *4</p>  </div> <div style="text-align: center;"> <p>Right-side mounting (DIN Rail) *4</p>  </div> </div>

*1. When using 480 W on a ship, use the S82Y-VK90F.

*2. You are recommended to secure the bracket using the four outer mounting holes. (480 W/960 W)

The mounting holes are the same as S82Y-VK10F. The bracket can also be secured using the four inner mounting holes. (480 W only)

*3. Side-mounting brackets are not compliant with marine standards.





*4. You can mount the side of the Power Supply to a DIN Rail by removing the DIN Rail Back-mounting Bracket and then attaching a Side-mounting Bracket to the Power Supply.

Safety Precautions

Warning Indications

 WARNING	Indicates a potentially hazardous situation which, if not avoided, will result in minor or moderate injury, or may result in serious injury or death. Additionally, there may be significant property damage.
 CAUTION	Indicates a potentially hazardous situation which, if not avoided, may result in minor or moderate injury or in property damage.
Precautions for Safe Use	Supplementary comments on what to do or avoid doing, to use the product safely.
Precautions for Correct Use	Supplementary comments on what to do or avoid doing, to prevent failure to operate, malfunction or undesirable effect on product performance.

Meaning of Product Safety Symbols

	Used to warn of the risk of electric shock under specific conditions.
	Used to warn of the risk of minor injury caused by high temperatures.
	Used to indicate prohibition when there is a risk of minor injury from electrical shock or other source if the product is disassembled.
	Used for general CAUTION, WARNING, or DANGER precautions for which there is no specified symbol. (This symbol is also used as the alerting symbol, but shall not be used in this meaning on the product.)
	Used for general mandatory action precautions for which there is no specified symbol.

WARNING

During Product failure, fire or electric shock may occur. Be sure to use the recommended circuit-breaker or fuse. (Refer to *Recommended Circuit-breakers and Fuses* on page 14 for details.)



CAUTION

Minor electric shock, fire, or Product failure may occasionally occur. Do not disassemble, modify, or repair the Product or touch the interior of the Product.



Minor burns may occasionally occur. Do not touch the Product while power is being supplied or immediately after power is turned OFF.



Fire may occasionally occur. Tighten terminal screws to the specified torque.

S8VK-T12024, S8VK-T24024, S8VK-T48024:

4.43 to 5.31 lb-in (0.5 to 0.6 N·m)

S8VK-T96024:

10.62 to 13.28 lb-in (1.2 to 1.5 N·m)



Minor injury due to electric shock may occasionally occur. Do not touch the terminals while power is being supplied.



Minor electric shock, fire, or Product failure may occasionally occur. Do not allow any pieces of metal or conductors or any clippings or cuttings resulting from installation work to enter the Product.



If an external circuit-breaker trips or a fuse blows, it is possible that a serious failure has occurred in the device. Do not re-apply the input.



Slight risk of fire. Use wires with heat resistance of 75°C min to wire the terminals. (960W output line only)



This is the product UL listed as Open Type equipment. It must be mounted in an enclosure that does not allow fire to escape externally. Enclosure type: Type 1 or more.



Precautions for Safe Use

Recommended Circuit-breakers and Fuses

- During the Product failure, fire or electric shock may occur. Be sure to use the recommended circuit-breaker or fuse.
- To comply with safety standards EN/IEC62477-1, and EN/IEC61558-2-16 and to ensure safety when using the Product, be sure to use the following recommended circuit-breakers or fuses to connect the input to the Product.

Model	Input	Recommended Items (per one Product)
S8VK-T12024	3-phase	Circuit breaker: 480 VAC min., 5 to 20 A, Type B, C, or D characteristics
	2-phase	Circuit breaker: 480 VAC min., 2 to 20 A, Type B, C, or D characteristics Fuse: 600 VDC min., 5 A, Fast-acting type
	DC	Fuse: 600 VAC min., 5 A, Fast-acting type
S8VK-T24024	3-phase	Circuit breaker: 480 VAC min., 5 to 20 A, Type B, C, or D characteristics
	2-phase	Circuit breaker: 480 VAC min., 3 to 20 A, Type B, C, or D characteristics Fuse: 600 VAC min., 5 A, Fast-acting type
	DC	Fuse: 600 VDC min., 5 A, Fast-acting type
S8VK-T48024	3-phase	Circuit breaker: 480 VAC min., 4 to 20 A, Type B, C, or D characteristics
	2-phase	Circuit breaker: 480 VAC min., 4 to 20 A, Type B, C, or D characteristics Fuse: 600 VAC min., 10 A, Fast-acting type
	DC	Fuse: 600 VDC min., 10 A, Fast-acting type
S8VK-T96024	3-phase	Circuit breaker: 480 VAC min., 5 to 20 A, Type B, C, or D characteristics
	2-phase	Circuit breaker: 480 VAC min., 8 to 20 A, Type B, C, or D characteristics Fuse: 600 VDC min., 10 A Fast-acting type

Note: Do not use the S8VK-T96024 with a DC input.

Network Types

- Wire the input as shown in the following figures depends on your power distribution system.
- In the case of 3-phase 4-wire system, without connecting the neutral wire, connect the other 3 wires to +L1, -L2, and (L3).

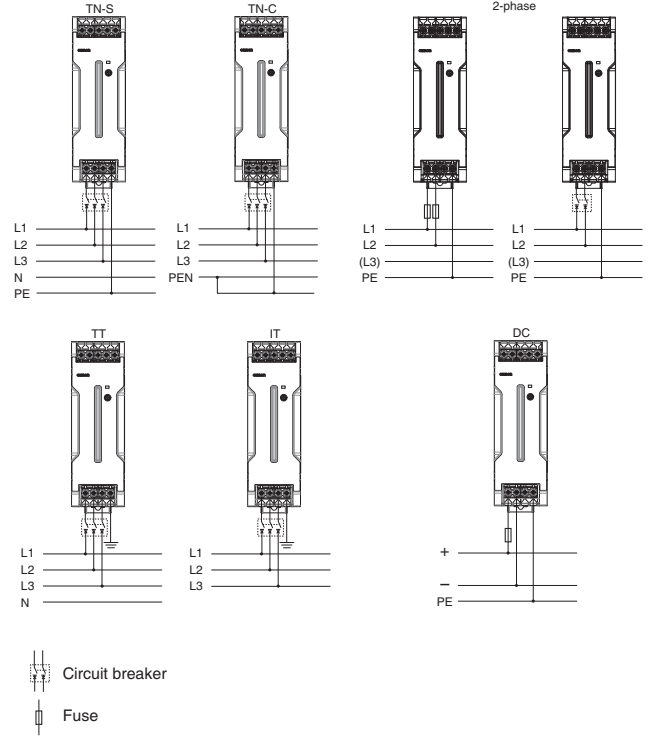

Wiring

- Connect the ground completely. A protective earthing terminal stipulated in safety standards is used. Electric shock or malfunction may occur if the ground is not connected completely.
- Minor fire may possibly occur. Ensure that input and output terminals are wired correctly.
- Do not apply more than 75-N force to the terminal block when tightening it.
- Be sure to remove the sheet covering the Product for machining before power-ON so that it does not interfere with heat dissipation.
- To prevent smoke and fire from wiring materials, check the wire ratings and use the wires shown in the table below.
- Use wires with heat resistance of 75°C min to wire the terminals. (960W output line only)

Recommended Wire Type/Cross-sectional Area and Stripping Length

Model	INPUT		OUTPUT		PE / Ground		Wire tripping Length
	American Wire Gauge	Solid Wire /Stranded Wire	American Wire Gauge	Solid Wire /Stranded Wire	American Wire Gauge	Solid Wire /Stranded Wire	
S8VK-T12024	AWG22 to 10	0.35 to 6 mm ² /0.35 to 4 mm ²	AWG18 to 10	0.75 to 6 mm ² /0.75 to 4 mm ²	AWG14 to 10	2.5 to 6 mm ² /2.5 to 4 mm ²	8 to 10 mm
S8VK-T24024	AWG22 to 10	0.35 to 6 mm ² /0.35 to 4 mm ²	AWG14 to 10	2.5 to 6 mm ² /2.5 to 4 mm ²			
S8VK-T48024	AWG20 to 10	0.5 to 6 mm ² /0.5 to 4 mm ²	AWG12 to 10	4 to 6 mm ² /4 mm ²			
S8VK-T96024	AWG16 to 6	1.5 to 16 mm ² /1.5 to 16 mm ²	AWG8 to 6	10 to 16 mm ² /10 to 16 mm ²	AWG14 to 6	2.5 to 16 mm ² /2.5 to 16 mm ²	13 to 16 mm

- The wire insertion hole, and applicable screwdriver of the terminal block are as follows.

Model	Wire Insertion Hole (Refer to the diagram on the right)		Applicable Screwdriver		
	W	L	No.	Driver Diameter	Length
S8VK-T12024	2.9	2.9	#2	4.9 mm max.	10 mm min.
S8VK-T24024					
S8VK-T48024					
S8VK-T96024	5.4	5	#2	5.1 mm max.	12 mm min.



Installation Environment

- Avoid places subject to shock or vibration. A device such as a contact breaker may be a vibration source. Install the Product away from contactors and other parts and devices that are sources of vibration.
- For usage onboard a ship, always attach an End Plate (PFP-M) to both sides of the Power Supply to hold the Power Supply in place. Use a S82Y-VK90F bracket to front-mount the 480 W. Side-mounting brackets are not compliant with marine standards.
- Install the Power Supply well away from any sources of strong, high-frequency noise and surge.

Ambient Operating and Storage Environments

- Store the Power Supply at a temperature of -40 to 85°C and a humidity of 95% or less.
- Do not use the product beyond the range of the derating curve for the installation direction, internal parts may occasionally deteriorate or be damaged.
- Use the Power Supply at a humidity of 0% to 95%.
- Do not use the Power Supply in locations subject to direct sunlight.
- Do not use the Power Supply in locations where liquids, foreign matter, or corrosive gases may enter the interior of Products.

Mounting

- Take adequate measures to ensure proper heat dissipation to increase the long-term reliability of the Product. Be sure to allow convection in the atmosphere around the product when mounting. Do not use in locations where the ambient temperature exceeds the range of the derating curve.
- Improper mounting will interfere with heat dissipation and may occasionally result in deterioration or damage of internal parts. Use the Product within the derating curve for the mounting direction that is used.
- When cutting out holes for mounting, make sure that cuttings do not enter the interior of the Products.
- The internal parts may occasionally deteriorate and be broken due to adverse heat radiation. Do not loosen the screws on the Product.

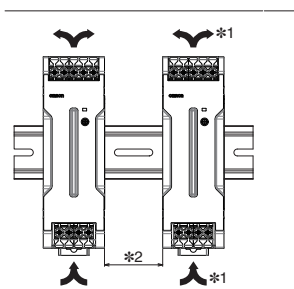

*1. Convection of air

*2. Horizontal separation 20 mm or more.

DIN Rail Mounting

To mount the product on a DIN Rail, hook portion (A) of the product onto the rail and press in the (B) direction.

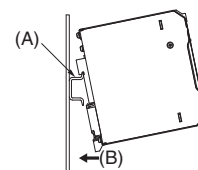

To dismount the Block, pull down portion (C) with a flat-blade screwdriver and pull out the Block.

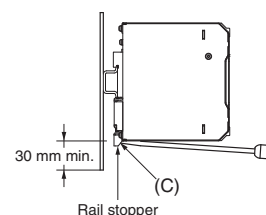

Power Boost Function

For All Models

The boost current is a temporary current that exceeds the rated current.

However, it should meet the following four boost current conditions.

- Time that the boost current flows: $t_1 \leq 10$ s
- The maximum value of the boost current: $I_p \leq$ Maximum boost current
- The average output current: $I_{ave} \leq$ Rated output current
- The time ratio of the boost current flow: Duty $\leq 30\%$

$$\text{Duty} = \frac{t_1}{t_1 + t_2} \times 100 [\%] \leq 30\%$$

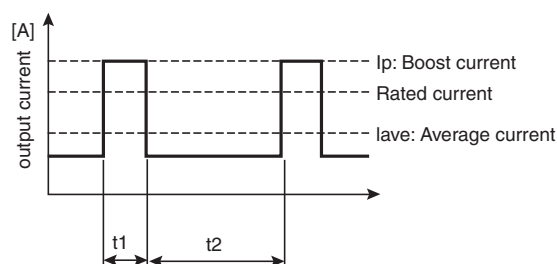

- Do not allow the boost current to continue for a long period of more than 10 seconds. Do not allow the duty to exceed 30%. These conditions may damage the product.
- Ensure that the average current of one cycle of the boost current does not exceed the rated output current. This may damage the product.
- Derate the load at the boost current and average output current according to the ambient operating temperature and mounting.
- For 960 W, boost current cannot be used during parallel operation (when the operation switch is set to the "PARALLEL" side).

Charging a Battery

If you connect a battery as the load, install overcurrent control and overvoltage protection circuits.

Output Voltage Adjuster (V.ADJ)

- The output voltage adjuster (V.ADJ) may possibly be damaged if it is turned with unnecessary force. Do not turn the adjuster with excessive force.
- After completing output voltage adjustment, be sure that the output capacity or output current does not exceed the rated output capacity or rated output current.

Series Operation

Two units of this product can be connected in series.

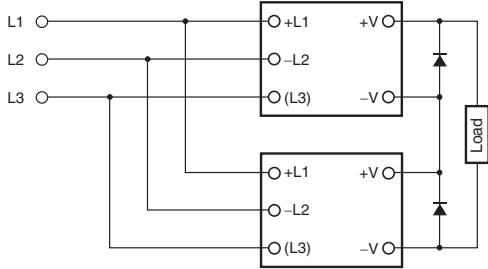

Note: 1. The diode is connected as shown in the figure. If the load is short-circuited, a reverse voltage will be generated inside the Power Supply. If this occurs the product may possibly deteriorate or be damaged. Always connect a diode as shown in the figure. Select a diode having the following ratings.

Type	Schottky Barrier diode
Dielectric strength (VRRM)	Twice the output voltage or above
Forward current (IF)	Twice the rated output current or above

- Although Products having different specifications can be connected in series, the current flowing through the load must not exceed the smaller rated output current.

Making Positive/Negative Outputs

- The outputs are floating outputs (i.e., the primary circuits and secondary circuits are separated). You can therefore make positive and negative outputs by using two units of this product. If positive and negative outputs are used, connect Power Supplies of the same series as in the following figure. (Combinations with different output capacities or output voltages can be made. However, use the lower of the two maximum rated output currents as the current to the loads.)

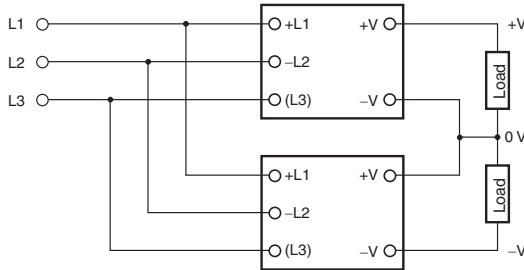

- Depending on the model, internal circuits may be damaged due to startup failure when the power is turned ON if loads such as a servomotor or operational amplifier may operate in series. Therefore, connect bypass diodes (D₁, D₂) as shown in the following figure. If the list of models that support series connection of outputs says that an external diode is not required, an external diode is also not required for positive/negative outputs.

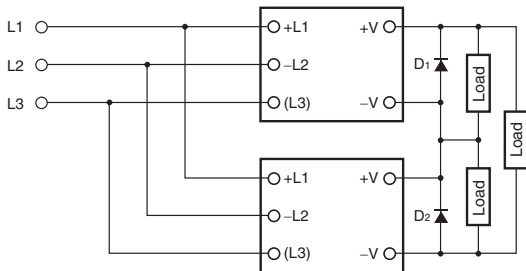

- Use the following information as a guide to the diode type, dielectric strength, and current.

Type	Schottky Barrier diode
Dielectric strength (VRRM)	Twice the output voltage or above
Forward current (IF)	Twice the rated output current or above

Parallel Operation

Parallel operation is used when the output current from one unit of this product is insufficient for the load. Units are connected in parallel to increase the output current.

Two units of this product can be connected in parallel. You must meet the following conditions to use parallel operation.

- Standard mounting
- Ambient temperature: -25 to +40°C
- 3-phase input voltage
- Use products of the same model for parallel operation.
- Adjust the output voltage difference of each unit to 50 mV or less, using the output voltage adjuster (V. ADJ).
- There is no current balancing function for the S8VK-T. A high output voltage unit may work at overcurrent state and in this situation, the life of the product will be extremely short. After adjusting the output voltage, confirm that the output current of the product balances.
- For parallel operation, to balance the current of the each unit, the length and thickness of each wire connected to the load and each unit must be same as much as possible.
- The output voltage may drop by several volts if the load changes rapidly (e.g., if the load starts or is disconnected). Use the S8VK-R or connect external diodes as shown in the figure. For parallel operation with 120 W products, use the S8VK-R10. For parallel operation with 240 W products, use the S8VK-R20.
- The internal parts may occasionally deteriorate or be damaged. For 960 W to operate in parallel, set the operation switch to the "PARALLEL" side.

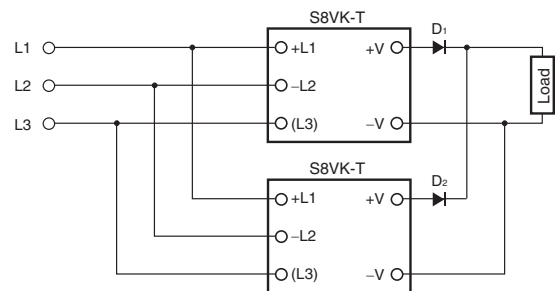
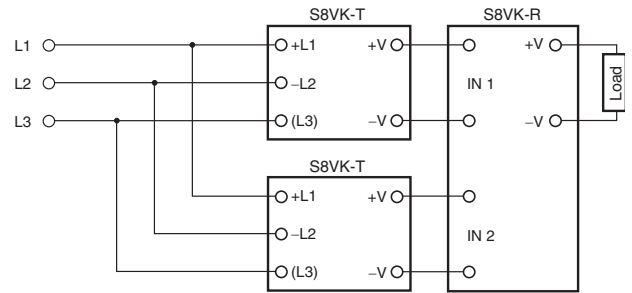

- Use the following information as a guide to the diode type, dielectric strength, and current.

Type	Schottky Barrier diode
Dielectric strength (VRRM)	Twice the output voltage or above
Forward current (IF)	Twice the rated output current or above

Backup Operation

Backup operation is possible if you use two units of the same model. Even if one Power Supplies fails, operation can be continued with the other Power Supply.

Make sure that the maximum load does not exceed the capacity of one product unit. Use the S8VK-R or connect external diodes.

For backup operation with 120 W or 240 W products, use the S8VK-R10. For backup operation with 480 W products, use the S8VK-R20.

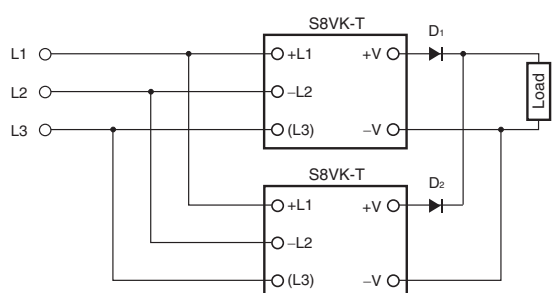
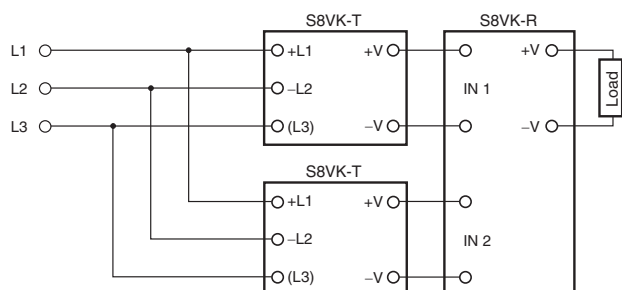

- Use the following information as a guide to the diode type, dielectric strength, and current.

Type	Schottky Barrier diode
Dielectric strength (VRRM)	Twice the output voltage or above
Forward current (IF)	Twice the rated output current or above

- Increase the output voltage setting of the Power Supplies by the drop in the forward voltage (VF) of diodes D1 and D2. Also, the diodes will cause a power loss equivalent to the Power Supply output current (IOUT) times the diode forward voltage (VF). Therefore, cooling measures must be implemented so that the temperature of the diodes decreases to the catalog value or lower.
- Because of the load power and power loss due to the diodes, do not exceed the rated power of one Power Supply (rated output voltage × rated output current).

In Case There Is No Output Voltage

The possible cause for no output voltage may be that the overcurrent or overvoltage protection has operated. The internal protection may operate if a large amount of surge voltage such as a lightning surge occurs while turning ON the power supply.

In case there is no output voltage, please check the following points before contacting us:

- Checking overload protected status:
 - Check whether the load is in overload status or is short-circuited. Remove wires to load when checking.
- Checking overvoltage or internal protection:
 - Turn the power supply OFF once, and leave it OFF for at least 5 minutes. Then turn it ON again to see if this clears the condition.

Audible Noise at Power ON

<S8VK-T48024, S8VK-T96024>

A harmonic current suppression circuit is built into the product. This circuit can create noise when the input is turned ON, but it will last only until the internal circuits stabilize and does not indicate any problem in the product.

Disposal

When disposing of the product, treat it as industrial waste.

S8VK-T

Period and Terms of Warranty

Warranty Period

The product warranty is valid for a period of three years from the date of shipment from the factory.

Terms of Warranty

The warranty is valid only for the following operating conditions.

1. Average ambient operating temperature of the product: 40°C max.
2. Average load rate: 80% max.
3. Mounting method: Standard mounting

* The maximum ratings must be within the derating curve.

If the product fails for reasons attributable to OMRON within the above warranty period, OMRON will repair or replace the faulty part of the product at the place of purchase or the place where the product delivered without charge.

This warranty does not cover the following types of failures.

- (1) Failures that result from handling or operation of the product under conditions or in environments that are not given in this document and not given in any other specifications exchanged between OMRON and the customer
 - (2) Failures that originate in causes other than the delivered product itself
 - (3) Failures caused by disassembly, modification, or repair of the product by anyone other than OMRON
 - (4) Failures caused by applications or uses for which the product was not originally intended
 - (5) Failures caused by factors that could not be anticipated with the scientific or technical knowledge available when the product was shipped
 - (6) Failures caused by other causes for which OMRON is not responsible, such as natural disasters and other acts of God
- This warranty is limited to the individual product that was delivered and does not cover any secondary, subsequent, or related damages.

Recommended Replacement Periods and Periodic Replacement for Preventive Maintenance

The recommended replacement period for preventive maintenance is greatly influenced by the application environment of the product. As a guideline, the recommended replacement period is 7 to 10 years.*

To prevent failures or accidents that can be caused by using a product beyond its service life, we recommend that you replace the product as early as possible within the recommended replacement period.

However, bear in mind that the recommended replacement period is for reference only and does not guarantee the life of the product.

Many electronic components are used in the product and the product depends on the correct operation of these components to achieve the original product functions and performance.

However, the influence of the ambient temperature on aluminum electrolytic capacitors is large, and the service life is reduced by half for each 10°C rise in temperature (Arrhenius law).

When the capacity reduction life of the electrolytic capacitor is reached, the product failures or accidents may occur.

We therefore recommend that you replace the product periodically to minimize product failures or accidents in advance.

* The recommended replacement period applies under the following conditions: rated input voltage, load rate of 50% max., ambient temperature of 40°C max., and the standard mounting method. (The fan is excluded for models with fans.)

This product model is designed with a service life of 10 years minimum under the above conditions.

Terms and Conditions Agreement

Read and understand this catalog.

Please read and understand this catalog before purchasing the products. Please consult your OMRON representative if you have any questions or comments.

Warranties.

- (a) Exclusive Warranty. Omron's exclusive warranty is that the Products will be free from defects in materials and workmanship for a period of twelve months from the date of sale by Omron (or such other period expressed in writing by Omron). Omron disclaims all other warranties, express or implied.
- (b) Limitations. OMRON MAKES NO WARRANTY OR REPRESENTATION, EXPRESS OR IMPLIED, ABOUT NON-INFRINGEMENT, MERCHANTABILITY OR FITNESS FOR A PARTICULAR PURPOSE OF THE PRODUCTS. BUYER ACKNOWLEDGES THAT IT ALONE HAS DETERMINED THAT THE PRODUCTS WILL SUITABLY MEET THE REQUIREMENTS OF THEIR INTENDED USE.

Omron further disclaims all warranties and responsibility of any type for claims or expenses based on infringement by the Products or otherwise of any intellectual property right. (c) Buyer Remedy. Omron's sole obligation hereunder shall be, at Omron's election, to (i) replace (in the form originally shipped with Buyer responsible for labor charges for removal or replacement thereof) the non-complying Product, (ii) repair the non-complying Product, or (iii) repay or credit Buyer an amount equal to the purchase price of the non-complying Product; provided that in no event shall Omron be responsible for warranty, repair, indemnity or any other claims or expenses regarding the Products unless Omron's analysis confirms that the Products were properly handled, stored, installed and maintained and not subject to contamination, abuse, misuse or inappropriate modification. Return of any Products by Buyer must be approved in writing by Omron before shipment. Omron Companies shall not be liable for the suitability or unsuitability or the results from the use of Products in combination with any electrical or electronic components, circuits, system assemblies or any other materials or substances or environments. Any advice, recommendations or information given orally or in writing, are not to be construed as an amendment or addition to the above warranty.

See <http://www.omron.com/global/> or contact your Omron representative for published information.

Limitation on Liability: Etc.

OMRON COMPANIES SHALL NOT BE LIABLE FOR SPECIAL, INDIRECT, INCIDENTAL, OR CONSEQUENTIAL DAMAGES, LOSS OF PROFITS OR PRODUCTION OR COMMERCIAL LOSS IN ANY WAY CONNECTED WITH THE PRODUCTS, WHETHER SUCH CLAIM IS BASED IN CONTRACT, WARRANTY, NEGLIGENCE OR STRICT LIABILITY.

Further, in no event shall liability of Omron Companies exceed the individual price of the Product on which liability is asserted.

Suitability of Use.

Omron Companies shall not be responsible for conformity with any standards, codes or regulations which apply to the combination of the Product in the Buyer's application or use of the Product. At Buyer's request, Omron will provide applicable third party certification documents identifying ratings and limitations of use which apply to the Product. This information by itself is not sufficient for a complete determination of the suitability of the Product in combination with the end product, machine, system, or other application or use. Buyer shall be solely responsible for determining appropriateness of the particular Product with respect to Buyer's application, product or system. Buyer shall take application responsibility in all cases.

NEVER USE THE PRODUCT FOR AN APPLICATION INVOLVING SERIOUS RISK TO LIFE OR PROPERTY OR IN LARGE QUANTITIES WITHOUT ENSURING THAT THE SYSTEM AS A WHOLE HAS BEEN DESIGNED TO ADDRESS THE RISKS, AND THAT THE OMRON PRODUCT(S) IS PROPERLY RATED AND INSTALLED FOR THE INTENDED USE WITHIN THE OVERALL EQUIPMENT OR SYSTEM.

Programmable Products.

Omron Companies shall not be responsible for the user's programming of a programmable Product, or any consequence thereof.

Performance Data.

Data presented in Omron Company websites, catalogs and other materials is provided as a guide for the user in determining suitability and does not constitute a warranty. It may represent the result of Omron's test conditions, and the user must correlate it to actual application requirements. Actual performance is subject to the Omron's Warranty and Limitations of Liability.

Change in Specifications.

Product specifications and accessories may be changed at any time based on improvements and other reasons. It is our practice to change part numbers when published ratings or features are changed, or when significant construction changes are made. However, some specifications of the Product may be changed without any notice. When in doubt, special part numbers may be assigned to fix or establish key specifications for your application. Please consult with your Omron's representative at any time to confirm actual specifications of purchased Product.

Errors and Omissions.

Information presented by Omron Companies has been checked and is believed to be accurate; however, no responsibility is assumed for clerical, typographical or proofreading errors or omissions.

Note: Do not use this document to operate the Unit.

OMRON Corporation Industrial Automation Company

Kyoto, JAPAN

Contact : www.ia.omron.com

Regional Headquarters

OMRON EUROPE B.V.

Wegalaan 67-69, 2132 JD Hoofddorp
The Netherlands
Tel: (31) 2356-81-300 Fax: (31) 2356-81-388

OMRON ELECTRONICS LLC

2895 Greenspoint Parkway, Suite 200
Hoffman Estates, IL 60169 U.S.A.
Tel: (1) 847-843-7900 Fax: (1) 847-843-7787

OMRON ASIA PACIFIC PTE. LTD.

438B Alexandra Road, #08-01/02 Alexandra
Technopark, Singapore 119968
Tel: (65) 6835-3011 Fax: (65) 6835-3011

OMRON (CHINA) CO., LTD.

Room 2211, Bank of China Tower,
200 Yin Cheng Zhong Road,
PuDong New Area, Shanghai, 200120, China
Tel: (86) 21-6023-0333 Fax: (86) 21-5037-2388

Authorized Distributor:

©OMRON Corporation 2014-2023 All Rights Reserved.
In the interest of product improvement,
specifications are subject to change without notice.

CSM_10_5

Cat. No. T061-E1-10 1123 (0414)