

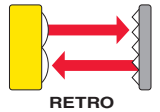

Features

- Reliable detection of clear, translucent, or opaque targets — including mirror-like surfaces
- Automatic compensation algorithm compensates for dust or contamination on the sensor or reflector and for ambient temperature changes
- 3 selectable thresholds based on type of target being detected
- Easy configuration via push buttons or remote wire
- Easy-to-read operating status indicators
- Rugged housing for harsh environments; rated IP67 (NEMA 6), 1200 psi washdown per NEMA PW12
- Compact housing, mounting versatility — 30 mm threaded barrel or side-mount



Models

Model	Sensing Range and Use*	Cable**	Supply Voltage	Output
QS30ELVC	100 mm to 2 m (3.9" to 78") Light SET for clear object detection	2 m (6.5') 5-wire cable	10 to 30V dc	Bipolar (NPN and PNP)
QS30ELVCQ		Integral 5-pin Euro-Style QD		

* Operation at shorter and longer distances possible. Contact factory for applications assistance.

** For 9 m (30') cable, add suffix "W/30" to the model number (e.g., **QS30ELVC W/30**).

For 150 mm (6") pigtail with a 5-pin Euro-style connector, add suffix "Q5" to the model number (e.g., **QS30ELVCQ5**).

For 150 mm (6") PUR cable with 5-pin threaded Euro-Style QD, add suffix "QPMA" to the model number (e.g. **QS30ELVCQPMA**).

A model with a QD connector requires a mating cordset (see page 9).

⚠ WARNING . . . Not To Be Used for Personnel Protection

Never use these products as sensing devices for personnel protection. Doing so could lead to serious injury or death.

These sensors do NOT include the self-checking redundant circuitry necessary to allow their use in personnel safety applications. A sensor failure or malfunction can cause either an energized or de-energized sensor output condition. Consult your current Banner Safety Products catalog for safety products which meet OSHA, ANSI and IEC standards for personnel protection.



139760

WORLD-BEAM® QS30ELVC Series

Overview

The QS30ELVC is an easy-to-use, high-performance retroreflective sensor optimized for detection of clear, translucent, or opaque objects. The optical design of the sensor ensures reliable detection of PET bottles, glass containers, and optically engineered surfaces such as mirrors, LCD glass with polarizing films, or semi-conductor wafers. The sensor will not be tricked by specular reflections from the object under normal operating conditions.

The compact housing has a large, easy-to-see bargraph display for easy configuration and status monitoring during operation. The sensor housing can be side-mounted, using integral mounting holes, or front-mounted, via the 30 mm threaded barrel. A wide assortment of mounting brackets are also available for applications requiring adjustability or robust mechanical protection.

The QS30ELVC is configured for operation using the Light SET procedure described on page 4. The sensor is simply aligned to the included retroreflective target and the Light SET is initiated either via the push button or the remote wire input. A reliable detection is assured when the appropriate threshold for clear, translucent or dark object is selected.

Continued reliable operation is maintained as the thresholds adapt to changing signal levels over time using Banner Engineering's auto compensation tracking algorithm. The sensor tracks the amount of light returned at every opportunity and makes fine adjustments to the switching threshold as required due to dust or contamination in the environment building up on the lens window or reflector. If the retroreflector is cleaned, returning the light to its original level, the sensor quickly adapts and continues operating with no need to perform another Light SET procedure.

The sensor can recover from a cold power-up by re-using the stored threshold values from the last Light SET procedure. You only need to perform the Light SET procedure if the sensor is moved or the sensor to reflector separation distance is changed.

The sensor ships from the factory as a DARK OPERATE (DO), non-polarized retroreflective sensor with auto compensation enabled for easy set-up and reliable operation. The automatic compensation tracking algorithm can be disabled if required through the user SETUP buttons or the remote teach wire.

Indicators

The sensor's compact housing has a large, easy-to-see bargraph display plus bright LEDs for easy configuration and status monitoring during operation. Sensor power and output state are indicated by the green and amber LEDs located at the top of the sensor. Sensor configuration is indicated by the 5-segment amber display. Signal strength relative to the switchpoint is indicated by the 3-segment red Signal bargraph (see Figure 2).

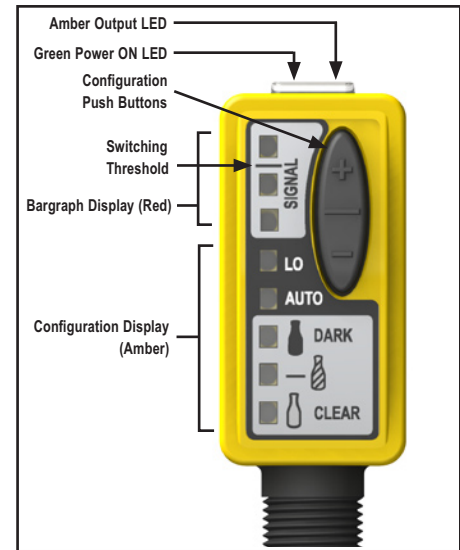

Figure 1. Features

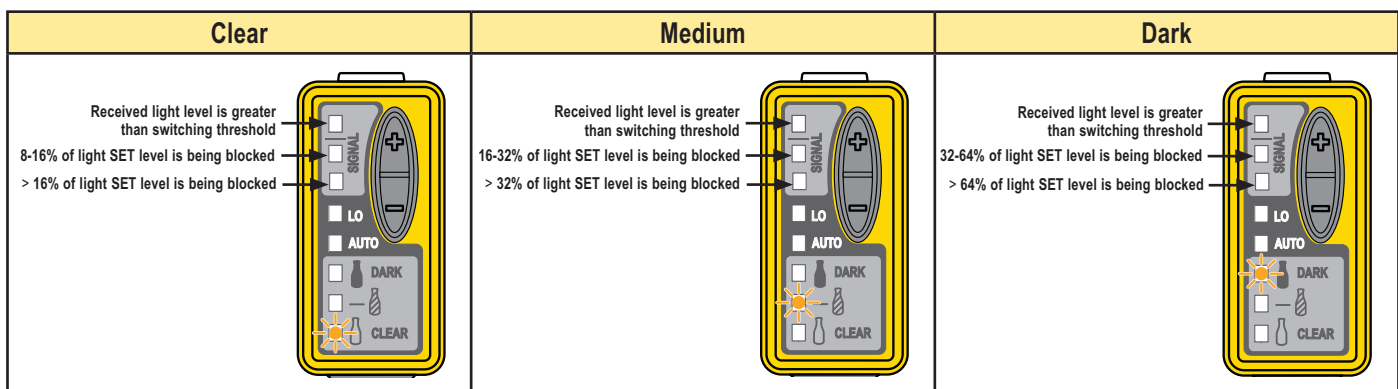

Figure 2. Signal strength relative to the switchpoint

Applications



Clear Bottle or Object Detection

1. Mount the retroreflector.
2. Align the sensor to the retroreflector.
3. Perform Light SET (page 4) with no object present.
4. Using Switchpoint Adjustment (page 6), select the darkest switchpoint which reliably detects the object. Medium level (16% below the signal from the retroreflector) will work for most applications. Dark level will provide more robust detection under difficult environmental conditions (e.g. dust, vibration, etc).

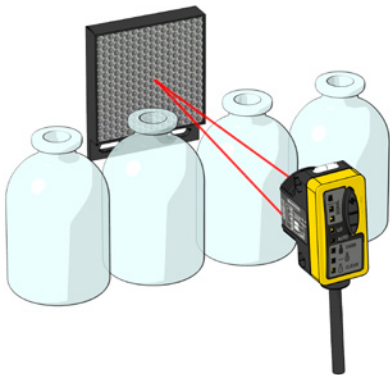

Clear Bottle or Object Counting

1. Mount the retroreflector.
2. Align the sensor to the retroreflector.
3. Disable the auto compensation function. Allow for 10 minute sensor warm-up period.
4. Position the bottles or objects so the beam is passing through the gap between the bottles.
5. Perform Light SET (page 4) on the gap condition.
6. Using Switchpoint Adjustment (page 6), select the darkest switchpoint which reliably detects the object. Medium level (16% below the signal from the retroreflector) will work for most applications. Dark level may provide more robust detection under difficult environmental conditions (e.g. dust, vibration, etc).

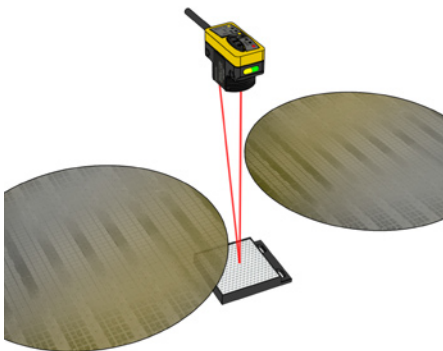

Reflective Object Detection

1. Mount the retroreflector.
2. Align the sensor to the retroreflector.
3. Perform Light SET (page 4) with no object present.
4. Using Switchpoint Adjustment (page 6), select clear or medium switchpoint percentage (8% or 16% below the signal from the retroreflector). This will reduce the chance of specular reflection affecting the sensor.

WORLD-BEAM® QS30ELVC Series

Single-Point Light SET

- Useful for clear object detection and other applications with small variations in contrast.
- Sets a switchpoint at 8 (clear), 16 (medium) or 32 (dark) percent below the signal from the retroreflector.
- Switchpoint position is selectable using the “+” and “-” buttons. Select 8, 16, or 32 percent (Switchpoint Selection).
- Sensor must be aimed at the reflector during the SET process. All conditions darker than the switchpoint condition result in ON output (Dark Operate). Output ON and OFF conditions can be reversed by changing Light/Dark Operate in SETUP mode (factory setting: Dark Operate).

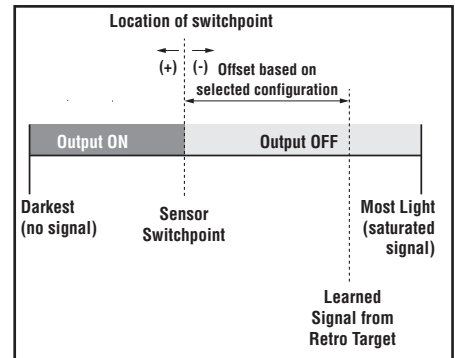

Figure 3. Low-contrast SET (Dark Operate shown)

	Push Buttons	Remote 0.04 seconds ≤ T ≤ 0.8 seconds	Indicators
Set Switchpoint	<ul style="list-style-type: none"> • Align sensor to reflector • Press and hold “+” > 2 seconds 	<ul style="list-style-type: none"> • Align sensor to reflector • Single-pulse remote line 	<p>Green Power LED: OFF Amber Output LED: ON Bargraph: Top two signal LEDs alternate flashing</p>
Sensor Feedback			<p>Switchpoint Accepted</p> <p>Green Power LED: ON Amber Output LED: ON (LO) or OFF (DO) Bargraph: Appropriate LED ON</p> <ul style="list-style-type: none"> • Sensor returns to RUN mode with new settings
			<p>Switchpoint Unacceptable</p> <p>Green Power LED: ON Amber Output LED: Flashing (Alarm State*) Bargraph: All OFF</p> <p>* See page 6</p>

SETUP Mode



SETUP mode is used to change sensor configuration:

- Light or Dark operate
- Enable or disable automatic compensation algorithm

If SETUP mode programming is interrupted and remains inactive for 60 seconds, the sensor returns to RUN mode with the most recent settings (i.e., exits and saves current selection).

SETUP mode operates in the “background”, while the outputs are active; changes are updated instantly.

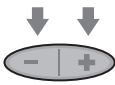
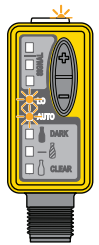
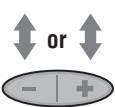
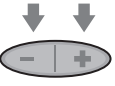
The sensor can be configured using the remote line (see page 7).

	Push Button 0.04 seconds ≤ “Click” ≤ 0.8 seconds	Result															
Access SETUP Mode	<ul style="list-style-type: none"> • Press and hold both push buttons > 2 seconds 	<p>Green Power LED: OFF Amber Output LED: Remains active Bargraph: Status indicators (LO and AUTO) flash current setup</p> 															
Select Setting Combination	<ul style="list-style-type: none"> • Click either push button until LEDs show desired settings 	<p>Sensor rotates through four setting combinations, in the following order:</p> <table border="1"> <thead> <tr> <th>Setting Combination</th> <th>Auto LED</th> <th>LO LED</th> </tr> </thead> <tbody> <tr> <td>Auto Compensation ON/DO*</td> <td>ON</td> <td>OFF</td> </tr> <tr> <td>Auto Compensation ON/LO</td> <td>ON</td> <td>ON</td> </tr> <tr> <td>Auto Compensation OFF/LO</td> <td>OFF</td> <td>ON</td> </tr> <tr> <td>Auto Compensation OFF/DO</td> <td>OFF</td> <td>OFF</td> </tr> </tbody> </table> <p>* Factory default setting</p>	Setting Combination	Auto LED	LO LED	Auto Compensation ON/DO*	ON	OFF	Auto Compensation ON/LO	ON	ON	Auto Compensation OFF/LO	OFF	ON	Auto Compensation OFF/DO	OFF	OFF
Setting Combination	Auto LED	LO LED															
Auto Compensation ON/DO*	ON	OFF															
Auto Compensation ON/LO	ON	ON															
Auto Compensation OFF/LO	OFF	ON															
Auto Compensation OFF/DO	OFF	OFF															
Return to RUN Mode	<ul style="list-style-type: none"> • Press and hold both push buttons > 2 seconds 	<p>Green Power LED: ON Amber Output LED: Remains active Bargraph: Indicates current setup</p> <ul style="list-style-type: none"> • Sensor returns to RUN mode with new settings 															

WORLD-BEAM® QS30ELVC Series

Switchpoint Selection

The switchpoint can be selected during RUN mode and is accomplished via the push buttons or the remote wire (see Remote Line TEACH, page 7).

Switchpoint selection via push buttons:

- Press “+” and “-” to select desired switchpoint
- Three possible choices; 8, 16 or 32 percent below the signal from the retroreflector.
Selection does not wrap around.

The sensor continues operating normally with the newly selected threshold value. It is not necessary to repeat the light SET.

Push Button Disable

In addition to its configuration function, Remote Configuration may be used to disable the push buttons for security. Disabling the push buttons prevents undesired tampering with the configuration settings. The Green Power LED blinks 4 times if a push button is pressed while they are locked out. The sensor continues operating normally and ignores the button press. Connect the gray wire of the sensor as described on page 2, and four-pulse to either enable or disable the push buttons:

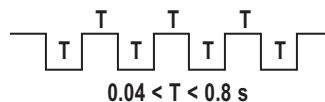

Alarm State

The QS30ELVC Alarm State indicates that the sensor requires attention. In all situations, the alarm can be cleared by realigning the sensor to the retroreflector, cleaning the sensor or retroreflector of contamination, and performing a Light SET to establish a valid light signal.

Alarm State is indicated by:

- Amber Output LED flashing
- All 3 Red Signal LEDs OFF
- Output forced to blocked state (i.e. if sensor is in dark operate (DO), the output is conducting)

The sensor may enter Alarm State for three reasons:

1. The sensor may be in Alarm State when first powered up. This is normal operation and does not indicate a problem with the sensor. The Alarm State will be cleared when a valid Light SET is performed.
2. The sensor will enter Alarm State if the Light SET procedure fails. This indicates the sensor did not receive enough light from the retroreflector for reliable detection. Realign the sensor to the retroreflector, making sure all optical surfaces are free of contamination.

If the automatic compensation algorithm is enabled, the sensor may recover at this point and begin operating normally. It is not necessary to repeat the Light SET procedure. If automatic compensation has been disabled, the sensor will remain in the Alarm State until the alignment has been corrected and a Light SET is successfully completed.

3. The sensor can enter Alarm State if the auto compensation algorithm is enabled and the sensor has automatically adjusted the threshold as much as possible. The sensor and retroreflector should be cleaned, or the sensor should be realigned to the retroreflector. The sensor will automatically adapt to the new light level, or a Light SET can be performed to reestablish the light level.

In any case, the sensor can be returned to normal operation by ensuring a clean optical path, aligning the sensor to the retroreflector, and performing a Light SET procedure on the sensor.

Remote Line TEACH

General Notes

- Connect the gray wire of the sensor to ground (0V dc), with a remote programming switch connected between them
- **Run Mode** is the sensor's normal operating condition
- The duration of each **Pulse** is defined as "T": $0.04 < T < 0.8 \text{ s}$ 
- A **Hold** will exit TEACH MODE and return to Run Mode with previously saved changes. The duration of a **Hold** is: $T > 2 \text{ s}$
- A **Timeout** will occur if a condition is not registered within 60 seconds, causing the sensor to return to Run Mode (during sensor configuration only)
- Sensor configuration user feedback shown on Green LED. See flow chart below.

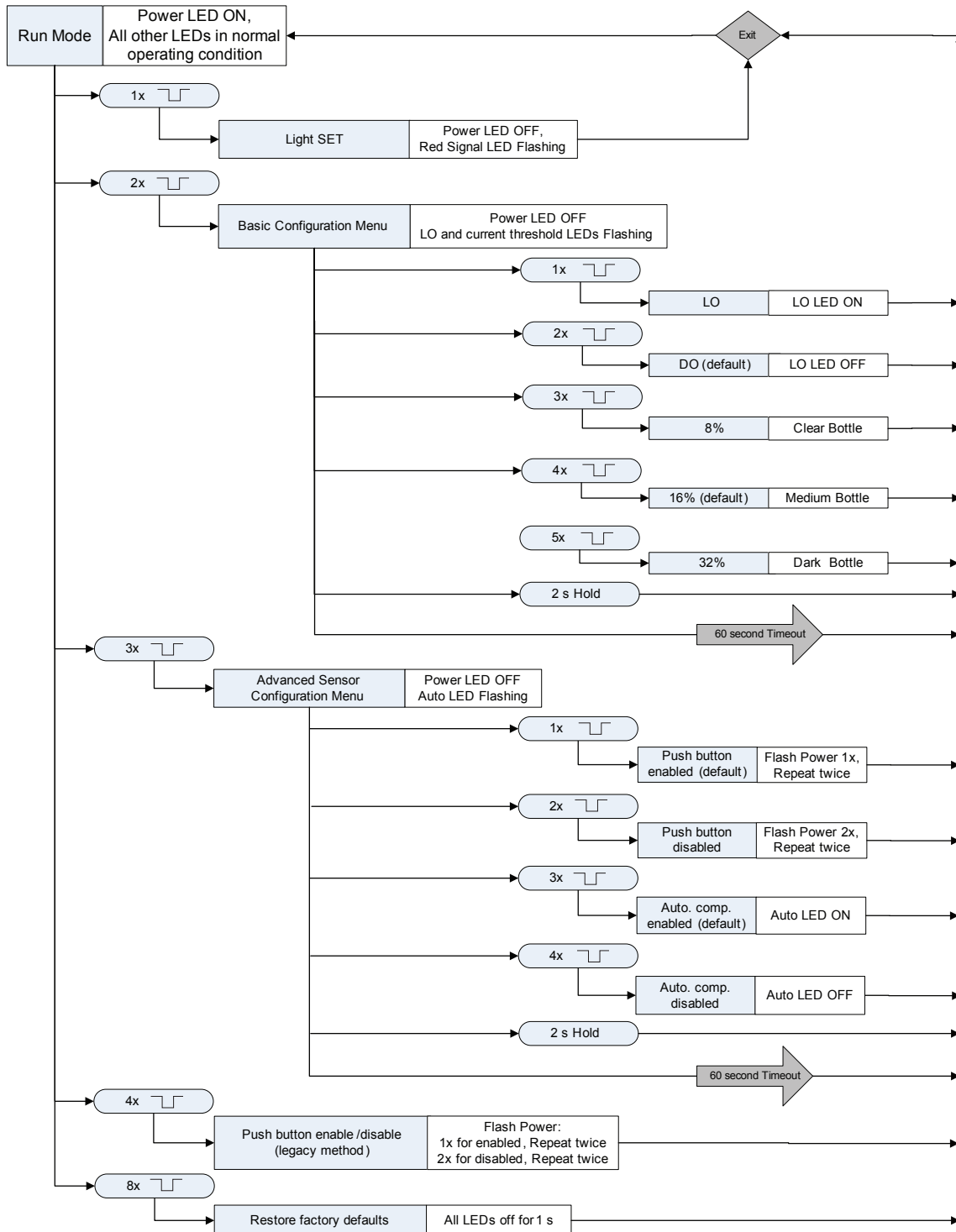

WORLD-BEAM® QS30ELVC Series

Specifications

Sensing Beam	660 nm visible red LED
Sensing Range and Use	100 mm to 2 m (3.9" to 78"); Light SET for clear object detection
Supply Voltage	10 to 30V dc (10% max. ripple) @ 25 mA max current, exclusive of load
Supply Protection Circuitry	Protected against reverse polarity, over voltage, and transient voltages
Delay at Power-Up	250 ms; outputs do not conduct during this time
Output Configuration	Bipolar: 1 current sourcing (PNP) and 1 current sinking (NPN)
Output Ratings	150 mA maximum load; see Application Note 1 OFF-state leakage current: < 50 μ A at 30V dc ON-state saturation voltage: NPN: < 200 mV @ 10 mA; < 1V @ 150 mA PNP: < 1.25V @ 10 mA; < 2V @ 150 mA
Output Protection	Protected against output short-circuit, continuous overload, transient over-voltages, and false pulse on power up
Output Response Time	500 microseconds
Repeatability	150 microseconds
Adjustments	2 push buttons and remote wire <ul style="list-style-type: none"> • Easy push-button configuration and deterministic remote wire configuration • Select from 3 standard thresholds based on object being detected • Light Operate/Dark Operate configuration options selectable via push buttons or remote wire • Push-button lockout (from remote wire only)
Indicators	Green LED: Power ON and feedback on configuration and remote wire pulses Amber LED: Output conducting or error condition (flashing) 3-Segment Red Signal Bargraph: Signal strength (excess gain), relative to switchpoint 5-Segment Amber Display: Sensor Configuration
Construction	ABS plastic housing; acrylic lens cover
Environmental Rating	Leakproof design rated IEC IP67 (NEMA 6); PW12 1200 PSI washdown
Connections	5-conductor 2 m (6.5') PVC cable, 9 m (30') PVC cable, 150 mm (6") pigtail with a 5-pin Euro-style connector, 150 mm (6") PUR cable with 5-pin threaded Euro-Style QD or 5-pin integral Euro-style quick-disconnect fitting
Operating Conditions	Temperature: -10° to +55°C (+14° to 122°F), Max. relative humidity: 95% @ 50°C (non-condensing)
Vibration and Mechanical Shock	All models meet Mil. Std. 202F requirements. Method 201A (Vibration: 10 to 60 Hz max. double amplitude 0.06", maximum acceleration 10G). Also meets IEC 947-5-2 requirements: 30G, 11 ms duration, half sine wave.
Application Notes	1. If supply voltage is > 24V dc, derate maximum output current 1 mA/°C above 25°C
Certifications	CE Pending

Hookups

Cabled Models

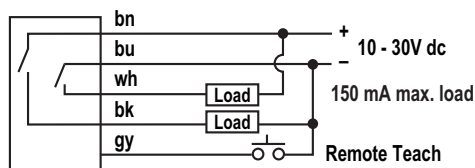

QD Models

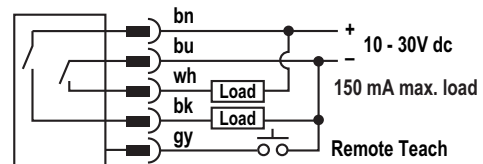

WORLD-BEAM® QS30ELVC Series

Dimensions

Cabled Models

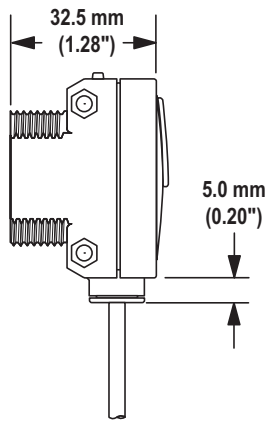

QD Models

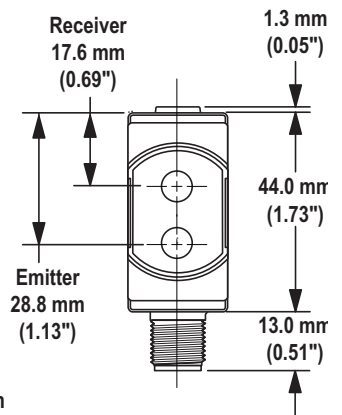
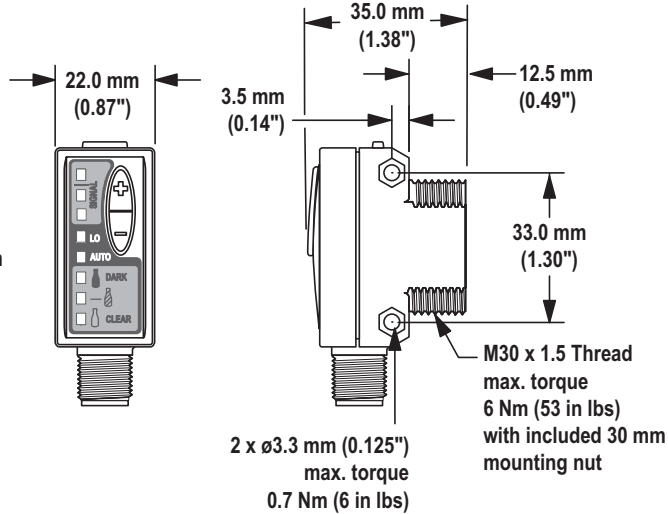
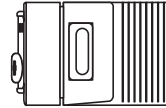

Hardware Included:

(10) M3 x 0.5 x 28 stainless steel machine screws, nuts and washers

Accessories







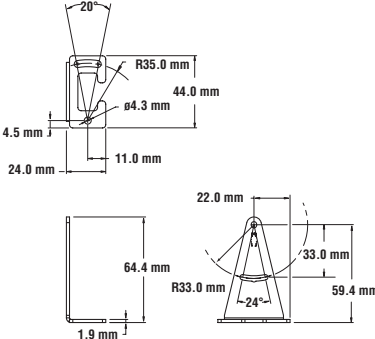

Quick-Disconnect Cables

Style	Model	Length	Dimensions	Pinout
5-pin Euro-style straight	MQDC1-506 MQDC1-515 MQDC1-530	2 m (6.5') 5 m (15') 9 m (30')		
5-pin Euro-style right-angle	MQDC1-506RA MQDC1-515RA MQDC1-530RA	2 m (6.5') 5 m (15') 9 m (30')		

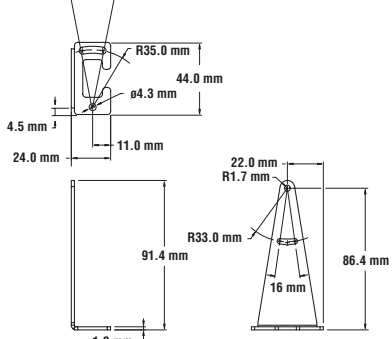
WORLD-BEAM® QS30ELVC Series

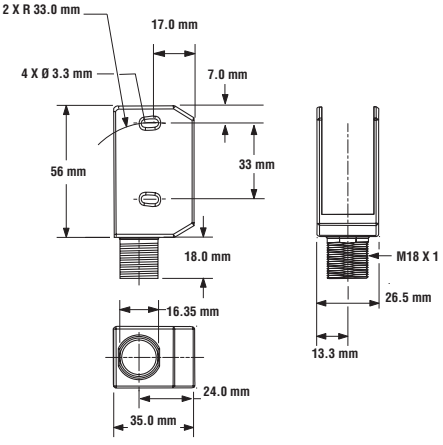
Mounting Brackets

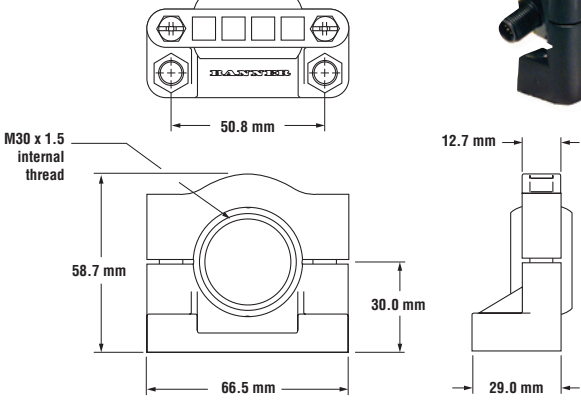
NOTE: Other sensor models shown on some views below.

<p>SMBQS30L</p> <ul style="list-style-type: none"> • Right-angle bracket for cabled sensors • 14-gauge stainless steel • $\pm 12^\circ$ tilt adjustment • Clearance for M4 (#8) hardware 	<p>SMBQS30LT</p> <ul style="list-style-type: none"> • Tall right-angle bracket for QD sensors with straight cordset connectors • 14-gauge stainless steel • $\pm 8^\circ$ tilt adjustment
 	 
<p>SMBQS30Y</p> <ul style="list-style-type: none"> • Heavy-duty die-cast bracket with M18 vertical mounting option • $\pm 8^\circ$ tilt adjustment for cabled sensors • Nuts and lockwasher included 	<p>SMB30SC</p> <ul style="list-style-type: none"> • Swivel bracket with 30 mm mounting hole for sensor • Black reinforced thermoplastic polyester • Stainless steel mounting and swivel locking hardware included
 	 
<p>Other Compatible Mounting Brackets (see Banner Photoelectric catalog or website for more information):</p> <ul style="list-style-type: none"> • SMB30MM • SMB30A • SMB30FA 	

WORLD-BEAM® QS30ELVC Series

Retroreflective Targets

Banner offers a wide selection of high-quality retroreflective targets. See the Accessories section of your current Banner Photoelectric Sensors catalog for complete information. NOTE: QS30ELVC sensors require corner cube type, large facet retroreflective targets only. Microprism and flexible tape reflectors are not recommended.

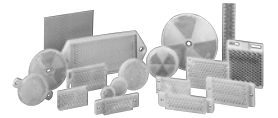

BRT-2X2LVC	<ul style="list-style-type: none"> • Corner-cube reflector • 1.0 reflectivity factor* • Max. temp. +50° C (+122° F) • Supplied with sensor 	BRT-40X19A	<ul style="list-style-type: none"> • Corner-cube reflector • 1.2 reflectivity factor* • Max. temp. +50° C (+122° F) • Supplied with sensor 	BRT-92X92C	<ul style="list-style-type: none"> • Corner-cube reflector • 3.0 reflectivity factor* • Max. temp. +50° C (+122° F) • Optional

*Reflectivity factor when compared with the standard BRT-3 reflector

WORLD-BEAM® QS30ELVC Series



WARRANTY: Banner Engineering Corp. warrants its products to be free from defects for one year. Banner Engineering Corp. will repair or replace, free of charge, any product of its manufacture found to be defective at the time it is returned to the factory during the warranty period. This warranty does not cover damage or liability for the improper application of Banner products. This warranty is in lieu of any other warranty either expressed or implied.

P/N 139760 rev. A

Banner Engineering Corp., 9714 Tenth Ave. No., Minneapolis, MN USA 55441 • Phone: 763.544.3164 • www.bannerengineering.com • Email: sensors@bannerengineering.com