

Metal One-touch Fittings

Applicable Tubing: Metric Size, Connection Thread: M, R, Rc

KQB2-F Series



Applicable Tubing

Tubing material*1	FEP, PFA, Nylon, Soft nylon, Polyurethane, Polyolefin
Tubing O.D.	Ø 3.2, Ø 4, Ø 6, Ø 8, Ø 10, Ø 12, Ø 16

*1 Considering the product application, FDA-compliant products are recommended.

Specifications

Fluid	Air, Water*1
Operating pressure range*2	-100 kPa to 1 MPa*3
Proof pressure	3.0 MPa
Ambient and fluid temperatures*4	-5 to 150°C (No freezing)*3
Lubricant	NSF H1 grease
Seal on the threads	Without sealant

*1 Deionised water is not recommended for use as it may affect the material used in the fittings. In addition, it is known to degrade the water quality.

*2 Do not use the fittings with a leak tester or for vacuum retention because they are not guaranteed for zero leakage.

*3 Check the operating pressure range and operating temperature range of the tubing.

*4 It is recommended that you use the inner sleeve in the following conditions. (Except Ø 3.2)

- When using in an environment where the fluid temperature changes drastically
- When using at a high temperature

* Temperature Condition of Mounting the Inner Sleeve

Tubing	Temperature
FEP tubing/TH series	80°C or more
Super PFA tubing/TL series	120°C or more

Spare Parts

Description	Tubing O.D.	Part no.	Material
O-ring	—	M-5-F	FDA compliant FKM
Bulkhead nut	Ø 3.2 Ø 4	KQB223-P01-F	C3604 (Electroless nickel plating)
	Ø 6	KQB206-P01-F	
	Ø 8	KQB208-P01-F	
	Ø 10	KQB210-P01-F	
	Ø 12	KQB212-P01-F	
	Ø 16	KQB216-P01-F	

Cross Reference Table of the Inner Sleeve

Tubing O.D.	Tubing material			Applicable inner sleeve	
	TUS (Soft polyurethane)	TH/THI (FEP)	TL/TIL (Super PFA)	Part no.	Length
Ø 4	—	TH0402	—	TJG-0402	18
	TUS0425	TH0425	—	TJG-0425	18
	—	—	TL0403	TJG-0403	18
Ø 6	TUS0604	TH0604	TL0604	TJG-0604	19
	TUS0805	—	—	TJG-0805	20.5
Ø 8	—	TH0806	TL0806	TJG-0806	20.5
	TUS1065	—	—	TJG-1065	23
Ø 10	—	TH1075	—	TJG-1075	23
	—	TH1008	TL1008	TJG-1008	24
	TUS1208	—	—	TJG-1208	24
Ø 12	—	TH1209	—	TJG-1209	24
	—	TH1210	TL1210	TJG-1210	24
	—	—	—	—	—

* Stainless steel 316 is used for the TJG series.

How to Order

KQB2 H 04 - 02 - F

Body type

Symbol	Model
H	Male connector, Straight union, Different diameter straight
S	Hexagon socket head male connector
L	Male elbow, Union elbow
T	Male branch tee, Union tee, Different diameter tee
E	Bulkhead union, Bulkhead connector
U	Union "Y", Different diameter union "Y"
R	Plug-in reducer
W	Extended male elbow
F	Female connector
P	Plug

Tubing size (Metric)

Symbol	Size
23	Ø 3.2
04	Ø 4
06	Ø 6
08	Ø 8
10	Ø 10
12	Ø 12
16	Ø 16

FDA compliant

Thread size, Tubing size

Symbol	Size	
M5	M5 x 0.8	Thread size
01	R1/8, Rc1/8	
02	R1/4, Rc1/4	
03	R3/8, Rc3/8	
04	R1/2, Rc1/2	Tubing size
00	Same tubing O.D.	
04	Ø 4	
06	Ø 6	
08	Ø 8	
10	Ø 10	
12	Ø 12	
16	Ø 16	

* Sealant is unavailable for this product as no FDA-compliant material is available.

Construction

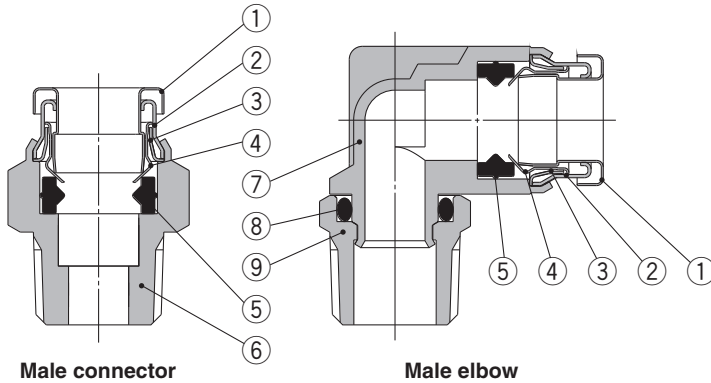

Component Parts

No.	Description	Material
1	Release button	Stainless steel 304
2	Guide 1	Stainless steel 304
3	Guide 2	Stainless steel 304
4	Chuck	Stainless steel 304
5	Seal	FDA compliant FKM (NSF H1 grease)
6	Male connector body	C3604 (Electroless nickel plating)
7	Male elbow body	Stainless steel 316
8	O-ring	FDA compliant FKM (NSF H1 grease)
9	Stud	C3604 (Electroless nickel plating)

EHEDG Compliant

Metric M, G KFG2H□-E

Clean Design

Metric M, G KFG2H□-C

FDA Compliant

Metric M, R, Rc KQG2-F

Inch UNF, NPT KQG2-F

Metric G KQG2-F

Metric M, R, Rc KQB2-F

Inch UNF, NPT KQB2-F

Metric G KQB2-F

Metric R, Rc KFG2-F

Inch NPT KFG2-F

Metric G KFG2-F

Precautions

Metal One-touch Fittings **KQB2-F Series**

Applicable Tubing: Metric Size, Connection Thread: M, R, Rc

Dimensions

Male Elbow: KQB2L



Applicable tubing O.D. (mm)	Connection thread R, M	Model	H (Width across flats)	Ø D ^{*1}	Ø d	L ₁	L ₂	A ^{*2}	M	Effective area [mm ²] ^{*3}	Weight [g]
Ø 3.2	M5 x 0.8	KQB2L23-M5-F	8	8.3	8	13.1	15.9	16.1	12	2.6	6.7
	1/8	KQB2L23-01-F	10			14.9	17.2	3		8	
	1/4	KQB2L23-02-F	14			18.7	19.4	16.6			
Ø 4	M5 x 0.8	KQB2L04-M5-F	8	9.1	8	13.7	16.3	16.9	12.6	3.5	7.2
	1/8	KQB2L04-01-F	10			15.3	18	4.2		8.6	
	1/4	KQB2L04-02-F	14			19.1	20.2	17.5			
Ø 6	M5 x 0.8	KQB2L06-M5-F	8	11.4	8	14.7	17.4	19.1	13.6	3.5	9.2
	1/8	KQB2L06-01-F	10			16.4	20.3	10.2			
	1/4	KQB2L06-02-F	14			20.2	22.5	19.1			
	3/8	KQB2L06-03-F	17			21.6	23.5	31.2			
Ø 8	1/8	KQB2L08-01-F	12	13.7	8	18.6	18.3	23.3	16.1	21.6	14.8
	1/4	KQB2L08-02-F	14			21.5	24.9	20.8			
	3/8	KQB2L08-03-F	17			22.9	25.9	32.8			
Ø 10	1/8	KQB2L10-01-F	12	16.6	8	20	19.7	26.2	17	21.6	20.4
	1/4	KQB2L10-02-F	14			22.9	27.8	23.7			
	3/8	KQB2L10-03-F	17			24.3	28.8	34.5			
Ø 12	1/2	KQB2L10-04-F	22	18.7	8	28.5	31.7		18.6	50.2	62.6
	1/4	KQB2L12-02-F	14			22.6	24	29.9		27.4	
	3/8	KQB2L12-03-F	17			23.6	25.3	30.8		34.3	
Ø 16	1/2	KQB2L12-04-F	22	24.6	8	29.5	33.7		20.8	71	47
	3/8	KQB2L16-03-F	19			26.3	28	35.8		60.8	
	1/2	KQB2L16-04-F	22			27.3	31.8	38.3		100	62.6

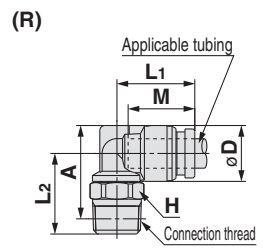
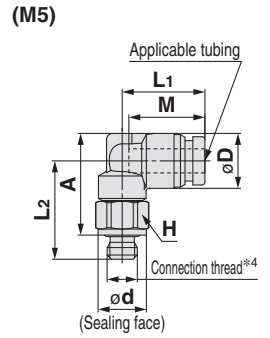

- *1 For the Ø 16, this dimension refers to the O.D. of the release button.
- *2 Reference dimensions after installation for R thread
- *3 Value of FEP tubing
Value of nylon tubing for Ø 16 only
- *4 In the case of M5, the screw length (Ø D/2 + L₂ - A) is longer than that of the KQB2 series.

Male Branch Tee: KQB2T



Applicable tubing O.D. (mm)	Connection thread R, M	Model	H (Width across flats)	Ø D ^{*1}	Ø d	L ₁	L ₂	A ^{*2}	M	Effective area [mm ²] ^{*3}	Weight [g]
Ø 3.2	M5 x 0.8	KQB2T23-M5-F	8	8.3	8	13.1	15.9	16.1	12	3.2	8.4
	1/8	KQB2T23-01-F	10			14.9	17.2	3.4		9.6	
	1/4	KQB2T23-02-F	14			18.7	19.4	18.4			
Ø 4	M5 x 0.8	KQB2T04-M5-F	8	9.1	8	13.7	16.3	16.9	12.6	4.5	9.3
	1/8	KQB2T04-01-F	10			15.3	18	6		10.6	
	1/4	KQB2T04-02-F	14			19.1	20.2	19.4			
Ø 6	M5 x 0.8	KQB2T06-M5-F	8	11.4	8	14.7	17.4	19.1	13.6	4.5	12.3
	1/8	KQB2T06-01-F	10			16.4	20.3	13.6			
	1/4	KQB2T06-02-F	14			20.2	22.5	22.5			
	3/8	KQB2T06-03-F	17			21.6	23.5	35			
Ø 8	1/8	KQB2T08-01-F	12	13.7	8	18.6	18.3	23.3	16.1	26.3	20
	1/4	KQB2T08-02-F	14			21.5	24.9	26.1			
	3/8	KQB2T08-03-F	17			22.9	25.9	38			
Ø 10	1/8	KQB2T10-01-F	12	16.6	8	20	19.7	26.2	17	40.8	28.6
	1/4	KQB2T10-02-F	14			22.9	27.8	31.5			
	3/8	KQB2T10-03-F	17			24.3	28.8	42.4			
Ø 12	1/2	KQB2T10-04-F	22	18.7	8	28.5	31.7		18.6	57.2	70.4
	1/4	KQB2T12-02-F	14			22.6	24	29.9		38.1	
	3/8	KQB2T12-03-F	17			23.6	25.3	30.8		39.7	
Ø 16	1/2	KQB2T12-04-F	22	24.6	8	29.5	33.7		20.8	71	70.8
	3/8	KQB2T16-03-F	19			26.3	28	35.8		64.4	
	1/2	KQB2T16-04-F	22			27.3	31.8	38.3		100	79

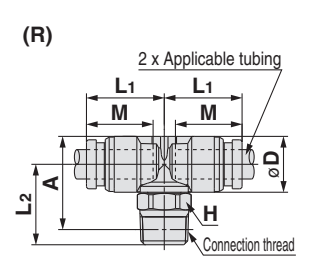
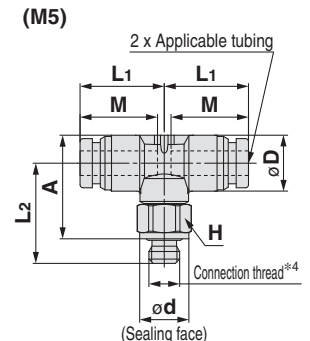

- *1 For the Ø 16, this dimension refers to the O.D. of the release button.
- *2 Reference dimensions after installation for R thread
- *3 Value of FEP tubing
Value of nylon tubing for Ø 16 only
- *4 In the case of M5, the screw length (Ø D/2 + L₂ - A) is longer than that of the KQB2 series.

EHEDG Compliant

Metric M, G KFG2H□-E

Clean Design

Metric M, G KFG2H□-C

FDA Compliant

Metric M, R, Rc KQG2-F

Inch UNF, NPT KQG2-F

Metric G KQG2-F

Metric M, R, Rc KQB2-F

Inch UNF, NPT KQB2-F

Metric G KQB2-F

Metric R, Rc KFG2-F

Inch NPT KFG2-F

Metric G KFG2-F

Precautions

KQB2-F Series

Applicable Tubing: Metric Size, Connection Thread: M, R, Rc

Dimensions

Union Elbow: KQB2L



Applicable tubing O.D. [mm]	Model	Ø D ^{*1}	L	A	Q	M	Ø N	Ø O	Effective area [mm ²] ^{*2}	Weight [g]
Ø 3.2	KQB2L23-00-F	8.3	13.6	19.3	2.9	12	3.2	5.6	3	6.3
Ø 4	KQB2L04-00-F	9.1	14.6	20.5	3.1	12.6	3.2	5.6	4.2	7.4
Ø 6	KQB2L06-00-F	11.4	16.6	23	3.6	13.6	3.2	5.6	11.4	11
Ø 8	KQB2L08-00-F	13.7	20.1	29.1	5	16.1	4.2	8	21.6	20.2
Ø 10	KQB2L10-00-F	16.6	22	31.7	5.7	17	4.2	8	35.2	29.6
Ø 12	KQB2L12-00-F	18.7	24.6	35	6.4	18.6	4.2	8	50.2	37.1
Ø 16	KQB2L16-00-F	24.6	28.8	40.5	7.7	20.8	4.2	8	100	59.7

*1 For the Ø 16, this dimension refers to the O.D. of the release button.

*2 Value of FEP tubing

Value of nylon tubing for Ø 16 only

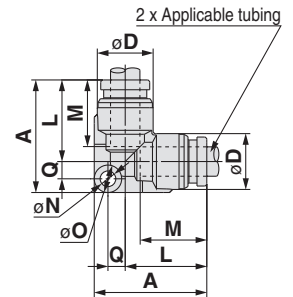

Bulkhead Union: KQB2E



Applicable tubing O.D. [mm]	Model	T (M)	H (Width across flats)	L	Mounting hole	M	Effective area [mm ²] ^{*1}	Weight [g]
Ø 3.2	KQB2E23-00-F	M10 x 1	12	32.2	11	12	3.4	14.8
Ø 4	KQB2E04-00-F	M10 x 1	12	32.4	11	12.6	5.6	14.7
Ø 6	KQB2E06-00-F	M14 x 1	17	35.4	15	13.6	13.1	29.2
Ø 8	KQB2E08-00-F	M15 x 1	19	38.8	16	16.1	26.1	34.9
Ø 10	KQB2E10-00-F	M18 x 1	21	40	19	17	41.5	47.1
Ø 12	KQB2E12-00-F	M20 x 1	24	42.4	21	18.6	58.3	58.7
Ø 16	KQB2E16-00-F	M27 x 1	30	46.8	28	20.8	113	107.2

*1 Value of FEP tubing

Value of nylon tubing for Ø 16 only

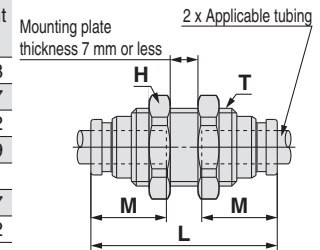

Union Tee: KQB2T



Applicable tubing O.D. [mm]	Model	Ø D ^{*1}	L	A	Q	M	Ø N	Ø O	Effective area [mm ²] ^{*2}	Weight [g]
Ø 3.2	KQB2T23-00-F	8.3	13.6	20.5	4.1	12	3.2	5.6	3.4	7.9
Ø 4	KQB2T04-00-F	9.1	14.6	21.8	4.4	12.6	3.2	5.6	6.4	9.5
Ø 6	KQB2T06-00-F	11.4	16.6	24.6	5.2	13.6	3.2	5.6	13.4	14.2
Ø 8	KQB2T08-00-F	13.7	20.1	31.1	7	16.1	4.2	8	25.6	24.4
Ø 10	KQB2T10-00-F	16.6	22	34	8	17	4.2	8	40	36.8
Ø 12	KQB2T12-00-F	18.7	24.6	37.7	9.1	18.6	4.2	8	57.4	47
Ø 16	KQB2T16-00-F	24.6	28.8	43.4	10.6	20.8	4.2	8	100	75.5

*1 For the Ø 16, this dimension refers to the O.D. of the release button.

*2 Value of FEP tubing

Value of nylon tubing for Ø 16 only

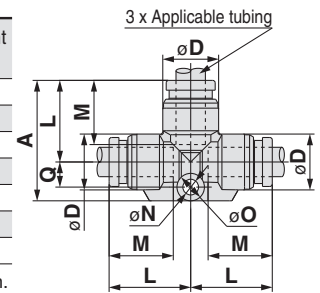

Union "Y": KQB2U



Applicable tubing O.D. [mm]	Model	Ø D ^{*1}	W	L ₁	L ₂	P	M	Ø N	Ø O	Effective area [mm ²] ^{*2}	Weight [g]
Ø 3.2	KQB2U23-00-F	8.3	16.4	29	11	8.1	12	3.2	5.6	3.4	9.2
Ø 4	KQB2U04-00-F	9.1	18.2	30.4	11.3	9.1	12.6	3.2	5.6	4.2	11.1
Ø 6	KQB2U06-00-F	11.4	22.9	34.9	12.2	11.5	13.6	3.2	5.6	13.4	18.8
Ø 8	KQB2U08-00-F	13.7	28.3	40.1	14.1	14.6	16.1	4.2	8	25.6	29.7
Ø 10	KQB2U10-00-F	16.6	34.2	44	14.4	17.6	17	4.2	8	40	47.4
Ø 12	KQB2U12-00-F	18.7	38.5	48.4	15.8	19.8	18.6	4.2	8	57.4	62.1
Ø 16	KQB2U16-00-F	24.6	49.3	56.6	17.3	26	20.8	4.2	8	113	110.2

*1 For the Ø 16, this dimension refers to the O.D. of the release button.

*2 Value of FEP tubing

Value of nylon tubing for Ø 16 only

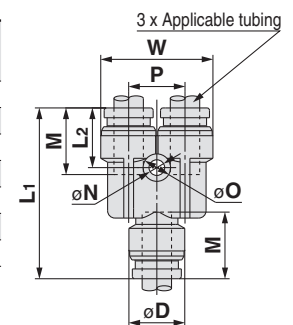

Metal One-touch Fittings

Applicable Tubing: Metric Size, Connection Thread: G*1

KQB2-F Series

*1 ISO 16030 compliant



Applicable Tubing

Tubing material*1	FEP, PFA, Nylon, Soft nylon, Polyurethane, Polyolefin
Tubing O.D.	Ø 4, Ø 6, Ø 8, Ø 10, Ø 12, Ø 16

*1 Considering the product application, FDA-compliant products are recommended.

Specifications

Fluid	Air, Water*1
Operating pressure range*2	-100 kPa to 1 MPa*3
Proof pressure	3.0 MPa
Ambient and fluid temperatures*4	-5 to 150°C (No freezing)*3
Lubricant	NSF H1 grease
Seal on the threads	O-ring seal

*1 Deionised water is not recommended for use as it may affect the material used in the fittings. In addition, it is known to degrade the water quality.

*2 Do not use the fittings with a leak tester or for vacuum retention because they are not guaranteed for zero leakage.

*3 Check the operating pressure range and operating temperature range of the tubing.

*4 It is recommended that you use the inner sleeve in the following conditions.
 · When using in an environment where the fluid temperature changes drastically
 · When using at a high temperature

* Temperature Condition of Mounting the Inner Sleeve

Tubing	Temperature
FEP tubing/TH series	80°C or more
Super PFA tubing/TL series	120°C or more

Spare Parts

Description	Tubing O.D.	Part no.	Material
Bulkhead nut	Ø 4	KQB223-P01-F	C3604 (Electroless nickel plating)
	Ø 6	KQB206-P01-F	
	Ø 8	KQB208-P01-F	
	Ø 10	KQB210-P01-F	
	Ø 12	KQB212-P01-F	
	Ø 16	KQB216-P01-F	

Description	Thread size	Part no.	Material
G thread O-ring	G1/8	KQB2-G01-F	FDA compliant FKM
	G1/4	KQB2-G02-F	
	G3/8	KQB2-G03-F	
	G1/2	KQB2-G04-F	

Cross Reference Table of the Inner Sleeve

Tubing O.D.	Tubing material			Applicable inner sleeve	
	TUS (Soft polyurethane)	TH/TH (FEP)	TL/TIL (Super PFA)	Part no.	Length
Ø 4	—	TH0402	—	TJG-0402	18
	TUS0425	TH0425	—	TJG-0425	18
	—	—	TL0403	TJG-0403	18
Ø 6	TUS0604	TH0604	TL0604	TJG-0604	19
	TUS0805	—	—	TJG-0805	20.5
Ø 8	—	TH0806	TL0806	TJG-0806	20.5
	TUS1065	—	—	TJG-1065	23
Ø 10	—	TH1075	—	TJG-1075	23
	—	TH1008	TL1008	TJG-1008	23
	TUS1208	—	—	TJG-1008	24
Ø 12	—	TH1209	—	TJG-1209	24
	—	TH1210	TL1210	TJG-1210	24

* Stainless steel 316 is used for the TJG series.

EHEDG Compliant

Metric M, G KFG2H-E

Clean Design

Metric M, G KFG2H-C

FDA Compliant

Metric M, R, Rc KQG2-F

Inch UNF, NPT KQG2-F

Metric G KQG2-F

Metric M, R, Rc KQB2-F

Inch UNF, NPT KQB2-F

Metric G KQB2-F

Metric R, Rc KFG2-F

Inch NPT KFG2-F

Metric G KFG2-F

Precautions

KQB2-F Series

Applicable Tubing: Metric Size, Connection Thread: G

How to Order

KQB2 H 04 - G 02 - F

• Body type

Symbol	Model
H	Male connector
S	Hexagon socket head male connector
L	Male elbow
T	Male branch tee
E	Bulkhead connector
W	Extended male elbow
F	Female connector

• FDA compliant

• Thread size

Symbol	Size
01	G1/8
02	G1/4
03	G3/8
04	G1/2

• Tubing size (Metric)

Symbol	Size
23	Ø 3.2
04	Ø 4
06	Ø 6
08	Ø 8
10	Ø 10
12	Ø 12
16	Ø 16

• Thread type

Symbol	Type
G	G

Construction

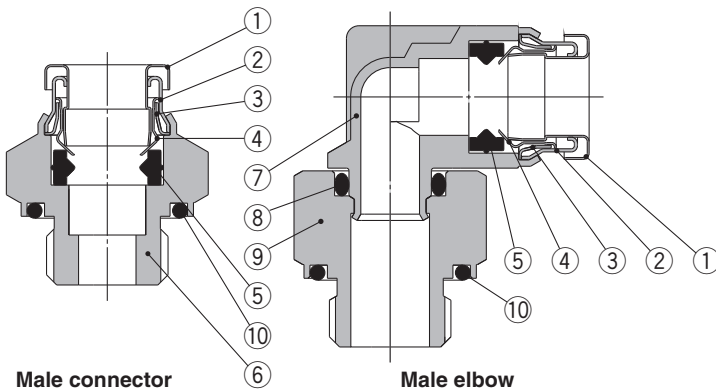

Component Parts

No.	Description	Material
1	Release button	Stainless steel 304
2	Guide 1	Stainless steel 304
3	Guide 2	Stainless steel 304
4	Chuck	Stainless steel 304
5	Seal	FDA compliant FKM (NSF H1 grease)
6	Male connector body	C3604 (Electroless nickel plating)
7	Male elbow body	Stainless steel 316
8	O-ring	FDA compliant FKM (NSF H1 grease)
9	Stud	C3604 (Electroless nickel plating)
10	G thread O-ring	FDA compliant FKM

KQB2-F Series

Applicable Tubing: Metric Size, Connection Thread: G

Dimensions

Male Elbow: KQB2L



Applicable tubing O.D. (mm)	Connection thread G	Model	H (Width across flats)	Ø D*1	Ø d	L1	L2	A	M	Effective area [mm ²]*2	Weight [g]
Ø 4	1/8	KQB2L04-G01-F	14	9.1	13.8	14.4	18.9	17.9	12.6	4.2	15.6
	1/4	KQB2L04-G02-F	19		17.8		22.3	20.3			33
Ø 6	1/8	KQB2L06-G01-F	14	11.4	13.8	15.9	20	20.2	13.6	11.4	17.2
	1/4	KQB2L06-G02-F	19		17.8		23.4	22.6			34.6
	3/8	KQB2L06-G03-F	22		21.8		25.9	24.1			54.5
Ø 8	1/8	KQB2L08-G01-F	14	13.7	13.8	18.6	21.3	22.6	16.1	21.6	20.2
	1/4	KQB2L08-G02-F	19		17.8		24.7	25			36
	3/8	KQB2L08-G03-F	22		21.8		27.2	26.5			55.6
Ø 10	1/8	KQB2L10-G01-F	14	16.6	13.8	20	22.7	25.5	17	21.6	25.7
	1/4	KQB2L10-G02-F	19		17.8		26.1	27.9			38.2
	3/8	KQB2L10-G03-F	22		21.8		28.6	29.4			56.2
	1/2	KQB2L10-G04-F	27		26.5		32.6	31.9			97.9
Ø 12	1/4	KQB2L12-G02-F	19	18.7	17.8	22.6	27.2	30	18.6	50.2	41.9
	3/8	KQB2L12-G03-F	22		21.8		29.6	31.4			54.3
	1/2	KQB2L12-G04-F	27		26.5		33.6	33.9			94.6
Ø 16	3/8	KQB2L16-G03-F	22	24.6	21.8	26.3	32.4	36.5	20.8	71	64.7
	1/2	KQB2L16-G04-F	27		26.5		27.3	36.4			39

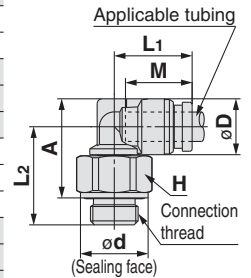

*1 For the Ø 16, this dimension refers to the O.D. of the release button.

*2 Value of FEP tubing
Value of nylon tubing for Ø 16 only

Male Branch Tee: KQB2T



Applicable tubing O.D. (mm)	Connection thread G	Model	H (Width across flats)	Ø D*1	Ø d	L1	L2	A	M	Effective area [mm ²]*2	Weight [g]
Ø 4	1/8	KQB2T04-G01-F	14	9.1	13.8	14.4	18.9	17.9	12.6	6	17.5
	1/4	KQB2T04-G02-F	19		17.8		22.3	20.3			34.9
Ø 6	1/8	KQB2T06-G01-F	14	11.4	13.8	15.9	20	20.2	13.6	13.9	21
	1/4	KQB2T06-G02-F	19		17.8		23.4	22.6			38
	3/8	KQB2T06-G03-F	22		21.8		25.9	24.1			57.9
Ø 8	1/8	KQB2T08-G01-F	14	13.7	13.8	18.6	21.3	22.6	16.1	26.3	25.6
	1/4	KQB2T08-G02-F	19		17.8		24.7	25			41.2
	3/8	KQB2T08-G03-F	22		21.8		27.2	26.5			60.8
Ø 10	1/8	KQB2T10-G01-F	14	16.6	13.8	20	22.7	25.5	17	40.8	34
	1/4	KQB2T10-G02-F	19		17.8		26.1	27.9			46
	3/8	KQB2T10-G03-F	22		21.8		28.6	29.4			64
	1/2	KQB2T10-G04-F	27		26.5		32.6	31.9			105.8
Ø 12	1/4	KQB2T12-G02-F	19	18.7	17.8	22.6	27.2	30	18.6	57.2	53
	3/8	KQB2T12-G03-F	22		21.8		29.6	31.4			54.3
	1/2	KQB2T12-G04-F	27		26.5		33.6	33.9			105
Ø 16	3/8	KQB2T16-G03-F	22	24.6	21.8	26.3	32.4	36.5	20.8	71	82.2
	1/2	KQB2T16-G04-F	27		26.5		27.3	36.4			39

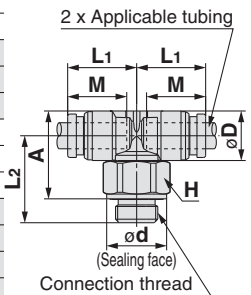

*1 For the Ø 16, this dimension refers to the O.D. of the release button.

*2 Value of FEP tubing
Value of nylon tubing for Ø 16 only